

dBblue



ACOUSTIC SOIL & WASTE SYSTEM

dBblue



dBlue - Complete and Reliable SYSTEM for the Modern Construction Industry



MATERIAL
FORMULA



KNOW-HOW



PROCESS



DELIVERY



PRODUCT



TECHNICAL
CONSULTANCY



ACOUSTIC
TESTING



QUALITY



FIXING

INTRODUCTION

Today's development of the construction industry is dynamically heading towards high quality, optimum functionality, safety and ecology of projects. Residential construction is one of the fastest growing sectors. It features investments into apartments, offices, hotels and single-family houses ie investments where comfort and safety of use are the highest priorities. An installation system that quietly and safely discharges waste from buildings is a modern product meeting both of the above-mentioned requirements. Commonly called an acoustic soil & waste system it combines

many aspects and technical solutions in the area of acoustics and hydraulics. The new version of the acoustic soil & waste system dBlue, produced by Nicoll, presents a host of innovative and comprehensive solutions for the modern construction industry. New applications and exceptional features make it the unquestionable leader in its class. Publishing this Specification Manual we trust that you will find within all the information and solutions used in everyday engineering practice.

Nicoll Polska Team

- high level of noise attenuation in an installation

One of the best results in the available acoustic systems



- programme of dedicated brackets for buildings of the highest acoustic comfort

"Phonoklip" vibration absorbing acoustic bracket



- programme of dedicated brackets for buildings of a high acoustic comfort

Attenuating steel acoustic dBlue bracket



- the best acoustic result out of similar acoustic systems in terms of unit flow rates

Flushing unit
Q = 2 l/s



- solutions in acoustics and ventilation for soil and waste stacks in high and high-rise buildings

Akavent ventilation fitting



- possibility of using it as a complete acoustic rain drainage system

dBlue rain gravitational stacks



- programme of innovative acoustic fittings reducing air-born noise in horizontal sections of an installation

Noise reduction by 6 dB



- the highest quality of products

Monitored by a professional laboratory



- support and technical consultancy in the product and its applications

Project calculation



- comprehensive and complementary offer of other systems

System solutions



NICOLL – GLOBAL LEADER IN INSTALLATION SYSTEMS FOR THE CONSTRUCTION INDUSTRY

ALIAxis GROUP

Aliaxis Group is a global leader in the production and distribution of plastic solutions for the construction industry in the following systems:

- installation
- ventilation
- water supply
- waste water treatment
- rainwater management
- irrigation
- public infrastructure

Today Aliaxis Group employs over 16 000 people in 46 countries in 100 distribution and production facilities.

NICOLL

Nicoll has been an Aliaxis Group company since 1980 as one of Europe's first producers of high-quality plastic fluid solutions for the construction industry. The company was founded in 1956 in France. Its head office is in Cholet, France. Today Nicoll encompasses 14 companies located across Europe and employing over 3 000 qualified personnel. 10 production sites churn out a host of systems and the biggest one is producing 12 000 components for various product families daily.

NICOLL TODAY:

- 10 production sites operating on 30 hectares
- 5 types of processed raw material: PVC, polypropylene, polyethylene, polyester, elastomer
- 6 000 products in its offer
- 5 types of raw material processing: extrusion, co-extrusion, injection, gluing, welding
- Research & Development Centre,
- Testing laboratory including a specialist acoustic laboratory.

NICOLL POLSKA

Nicoll Polska (Poliplast) was set up in 1989. It was at the time one of the first professional producers of waste water installation and environment protection systems for the construction industry (Photo 1).

Ever since its inception the company's objective has been the production of high-quality waste water management solutions. In 2000 Nicoll Polska was acquired by Aliaxis Group, a global leader in plastic solutions for fluid transport in building, industrial and utilities applications. The international group opened new international business opportunities for the company and know-how exchange. Nicoll Polska saw further dynamic growth.

Today Nicoll Polska is one of Poland's biggest producers of installation and sanitary systems. As the Aliaxis Group's soil & waste competence center the company supplies its systems to both domestic and export customers to over 30 countries worldwide including such faraway and dynamic construction markets as Australia, New Zealand, the United Arab Emirates, Oman, Indonesia, Singapore, Vietnam or Mongolia.

Thanks to its twenty-years' experience in producing plastic fluid systems Nicoll Polska has been successful in rolling out new solutions in its product offering and state-of-the-art technologies.

The company has been upgrading its product portfolio and developing new innovative products for the sanitary and installation industry.



Photo 1

NICOLL POLSKA – OFFER

The company offers complete installation and infrastructure solutions used in residential construction as well as in the industry and agriculture.

Nicoll Polska's solutions are applied in the following:

- safe evacuation of waste water
- gravitational and siphonic rain water drainage
- waste water evacuation as soil & waste installations in high-rise buildings with enhanced acoustic standards
- intake of precipitation water from large surfaces
- rain water and treated waste management and infiltration

Our Research and Development experts are continuously working on the development of today's offer closely following the market trends, product developments as well as health and environment protection aspects. Each system boasts complete technical support. All the systems are produced and applied in compliance with European standards and relevant domestic approval requirements. We test the quality of our products on an ongoing basis on our production lines as well as in our in-house laboratory.

We care about our environment. To this end Nicoll Polska provides reliable solutions aimed at clean water and its management:

- enhanced soil & waste system - AmaxPro
- acoustic soil & waste system – dBlue
- acoustic rain water drainage system – dBlue
- siphonic roof drainage system – Akasion
- rain gutter system
- line drainage - Kenadrain
- storm water management – Waterloc
- specialist ventilation fitting – Akavent
- sanitary wastes and traps for buildings



Photo 2



Photo 3



Photo 4

Effective protection against waste installation noise...



dB *lue*
ACOUSTIC SOIL
& WASTE SYSTEM

WITH A VIEW TO SILENCE

ACOUSTICS IN THE CONSTRUCTION INDUSTRY – BASIC TERMINOLOGY

SOUND

It is an audible impression caused by a change of the atmospheric pressure and perceived as an acoustic wave propagating in an elastic medium such as a solid body, gas or liquid.

NOISE

It is a set of sounds irritating for a human being that in a short period of time may be harmful for one's health and in the long run may cause permanent damage to one's hearing.

NOISE REDUCTION

Consists in:

- limiting the power of its origin,
- insulation of propagation of waves and sounds,
- absorbing waves through an acoustic absorption

DECIBELS [dB]

It is a logarithmic unit commonly used in sound measurement. It does not define any specific value and that is why it is different from units such as a meter or a kilogram. The value only refers to a proportion between quantities where the first one is a level of measured sound and the second one is a measured reference level.

ACOUSTIC BACKGROUND

It is a noise at a specific place after switching off the tested source of noise.

SUMMING UP THE NOISE

It is the result of adding up acoustic levels expressed in decibels. Since the quantity is based on a logarithmic scale, it is not added up directly.

RULES FOR SUMMING UP THE NOISE

- adding up decibels of the same values gives a result of one of these values increased by 3 decibels
Example: 16 dB + 16 dB = 19 dB,
- adding up different values of decibels with the difference between them > 10 dB gives a result of the bigger of the values
Example: 16 dB + 28 dB = 28 dB,
- adding up different values of decibels with the difference between them ≤ 10 dB is calculated by applying the following formula:

$$dB = 10 \log \left(\sum_{i=1}^n 10^{\frac{L_i}{10}} \right)$$

L – level of acoustic pressure;

n – number of summed up sources;

INSTALLATION NOISE

It is a sum of sound waves coming from the technical equipment of a building. The most common sources are: waste water installations, ventilation devices, pumps, refrigerating units and lifts.

AIR-BORNE NOISE

It is an irritating sound wave generated directly by a specific unit (solid body) and received by a human ear (e.g. waste water pipe during the flow of waste).

STRUCTURE-BORNE NOISE

It is an irritating sound wave generated by the transmission of acoustic vibrations from one solid unit (a vertical stack during the flow of waste) to another unit resulting in the second one generating sound waves (a building's wall onto which the stack is installed).

ACCEPTABLE NOISE LEVEL

In accordance with the Polish Construction Law a building and its location as well as devices located in it should ensure the users' comfort of work and sleep. Relevant standards set forth acceptable noise levels [dB] dividing it into periods of occurrence:

- day time (between 6:00 am and 10:00 pm),
- night time (between 10:00 pm and 6:00 am).

From among all types of noise, the installation noise is the one that is tolerated by a human ear most poorly. Officially appointed bodies (Sanitary and Epidemiological Inspection Body) carry out assessments of the effects of noise and its real level.

CHANGING THE NOISE SOURCE LEVEL

– ACOUSTIC BALANCE

It is the result of summing up values of noise levels in a given location or room which is aimed at defining its final acoustic characteristics [dB].

By comparing it to the acceptable sound levels an acoustic safety of a given place (room) is tested in relation to the applicable regulations.

REDUCTION OF THE ACOUSTIC BALANCE

It is achieved mainly by lowering the noise source power substituting traditional systems with systems of lowered noise emission. For example through substituting a traditional soil & waste system with an acoustic soil and waste system (Table 1).

Room acoustics vs. changing the level of noise of one of the sources.

Example: Reduction of the acoustic level balance in a bedroom at night time (permissible noise level – 25 dB) by substituting a standard soil & waste system with an acoustic one.



	Acoustic balance Before the change	Acoustic balance After the change
Source of noise – no. 1	21 dB	21 dB
Source of noise – no. 2	21 dB	21 dB
Source of noise – no. 3	25 dB	25 dB
Soil and waste system – no. 4	33 dB (standard)	16 dB (acoustic)
The sum of noise sources	28,4 dB > 25 dB	23 dB < 25 dB

Table 1



EVERYDAY NOISE

It is worth positioning dBlue noise reduction against everyday noise in our lives. The Fraunhofer Institute testing procedure for noise reduction in line with EN14366 (testing procedure and results description – chapter “Noise level measurement – acoustic system dBlue”) have shown dBlue to have a maximum noise level of 16dB. The graph below refers the 16dB value to everyday noise in our lives. It also defines to what extent specific noise sources affect human health and fitness. An ear as a hearing organ can record very low noise and endure very loud noise at the same time.

The following graph (Figure 1) shows that the difference between noise emitted by dBlue and a loud conversation is 14dB. A human ear can hear a minimum noise level of 3dB. This means that a noise level increase of 14dB is a multiple and sizable audible difference for the ear, which in the long term becomes irritating. The construction industry sets acceptable noise levels in various rooms. 5 dB is taken to be a minimum noise reduction value to enhance the rooms’ acoustics and perception by the human ear. This is why permissible noise levels in the construction industry discussed in the following section differ in particular rooms by the 5dB value.

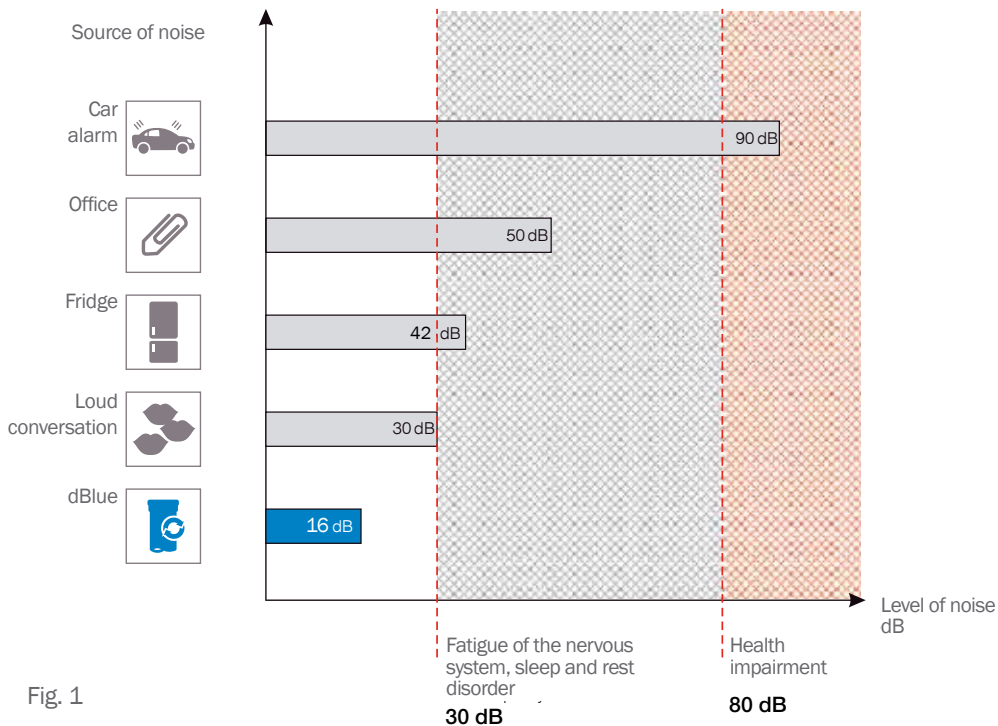

Fig. 1

ACOUSTIC SAFETY IN ROOMS ACCEPTABLE NOISE STANDARDS

Acceptable noise level to which a human being is exposed going around their daily business or having a rest is defined as 'a boundary noise level value'. Testing a noise level is broken down into two categories in line with the binding standards:

I CATEGORY – noise measured outdoor ie in the neighborhood, in the surroundings, in the open.

The European Directive (2002/49/WE) defines relevant regulations. It sets forth an acceptable noise level in a built-up area in daytime at 60dB and in night time at 50dB*.

* daytime – 0600 am – 1000 pm

night time – 1000 pm – 0600 am

II CATEGORY – noise measured indoors.

The Polish legal regulations defining permissible noise levels inside buildings are: Directive of the Minister of Infrastructure, Journal of Laws No. 75, item 690 of 2002 and the Polish Standard PN 87/B-02151/02 "Building acoustics. Protection of rooms in buildings against noise – Permissible sound level values in rooms" (Table 2).

The table below presents examples of acceptable noise level values in rooms used on a daily basis and designed for a human stay*. In the light of the maximum noise level emitted by dBlue (16dB) and the following standards it is evident that dBlue meets the most stringent minimum noise standards for habitable rooms.

ACCEPTABLE NOISE LEVEL VALUE IN HABITABLE ROOMS

Type of room	Acceptable average sound level – noise permeating to a room from a building's technical equipment and other facilities within a building and on its outside.	
	Daytime	Night time
Rooms for mental work requiring high concentration	30 dB	-
Rooms in 3-star hotels or less	40 dB	30 dB
Residential rooms in residential buildings, dormitories, old people's homes, orphanages, 4-star hotels and more	35 dB	25 dB
Intensive care unit wards	25 dB	25 dB
Hospital wards and sanatorium rooms except intensive care unit	30 dB	25 dB
Kitchens and sanitary rooms in apartments	40 dB	40 dB

Table 2

*The above acceptable sound levels in a given building type (room) refer to all noise sources, which for an installation noise concerns structure-borne or airborne noise.

While considering the use of the acoustic soil and waste dBlue system in the above rooms (buildings) all solutions offered by the system in the following areas should be taken into account:

- | | |
|--|----------------------------|
| 1/ Airborne noise | 2/ Structure-borne noise |
| - acoustic elbow | - 16dB (Phonoklip bracket) |
| - acoustic sleeve | - Stabilising elbow |
| - application as a rainwater drainage system | - Akavent Aerator fitting |

Table 3

ORIGIN AND REDUCTION OF NOISE COMING FROM WASTE WATER INSTALLATIONS

Any object in motion produces a sound transmitting sound waves and acoustic vibrations to a surrounding air as pressure or negative pressure waves. Waste water in the piping is the main source of the above phenomenon in waste water systems. This can be experienced in vertical stacks and in horizontal sections connecting to and finishing vertical stacks. Two types of installation noise are generated here: airborne and structure-borne. Both rooms through which the installation runs and the adjacent rooms should be protected against that noise. This is the task the acoustic soil & waste system needs to deal with; thanks to its design and applied installation solutions the system is to reduce the waste noise down to the value of noise permissible by applicable standards and regulations.

AIRBORNE NOISE IN THE dBlue SOIL & WASTE SYSTEM

Air-borne noise comes from the piping and is caused by waste flowing inside the piping (Fig. 2 - A). It is received directly by a human ear in a room where the system runs. In this case, the task of the acoustic soil & waste system is to limit the propagation of air sounds, absorbing them and locking them inside the piping. The acoustic dBlue soil & waste system does the above through several joint technical and technological solutions. The first solution is applying a special material formula using minerals in a 3-layer structure of the dBlue pipe. The second one involves the use of acoustic collars in horizontal sections; thanks to their design they absorb the emitted sounds. The third solution consists in using an acoustic elbow to join vertical stacks with horizontal sections. Thanks to its design and an absorbing section the elbow provides an obstacle for travelling sounds and acoustic vibrations.

STRUCTURE-BORNE NOISE

IN THE dBlue SOIL & WASTE SYSTEM

The structure-borne noise (Fig. 3 - B) comes from pipes and fittings as well as from the system of fixing to the construction of a building. The noise is generated by the afore-mentioned airborne noise (Fig. 3 - A) that being limited by pipes and fittings, makes them vibrate ie resonate acoustically. The resonance is transferred through a bracketing system onto the construction of the building and perceived in the adjacent rooms as an acoustic wave irritating and harmful for health (Fig. 3 - C). In this case it is essential that the pipes and fittings be fastened to the construction of the building so that the transmission of the acoustic resonance to its walls be as low as possible. The task is done by using specially designed acoustic brackets in the dBlue soil & waste system and the way they are fixed to the construction of the building.

VIBRATIONS AND ACOUSTIC BRIDGE

To confirm the above-mentioned theories a series of tests were carried out; in the first stage they allowed to specify the point of maximum acoustic vibrations in a vertical stack. They are mainly generated in the vertical stack piping and points of connecting horizontal sections that subsequently transfer acoustic vibrations onto the stack. The aforementioned test confirmed that the following are the most crucial factors in the total reduction of the waste noise in the entire soil & waste system: the structure and the material formula, the type and spacing of bracketing as well as technical solutions for a point (section) absorption of acoustic waves and vibrations. Another step was the development of a testing point for measuring vibrations (Photo 5) transferred by the brackets onto the structure of the building (acoustic bridge). Concurrently an optimum solution for the acoustic brackets was being developed and tested. The research and laboratory works were aimed at finding a complete and optimum system of pipes, fittings, and brackets of the maximum reduction [dB] of airborne and structure-borne noise in a building.

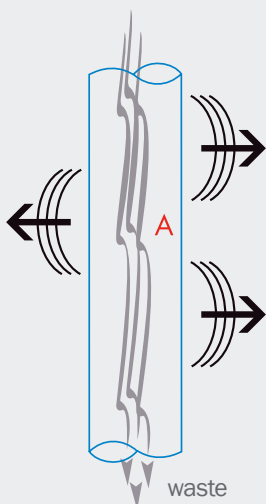

Fig. 2

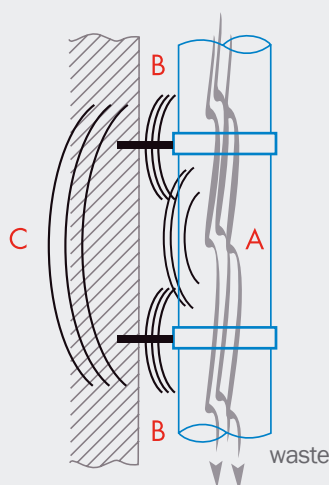

Fig. 3



Photo 5

**STRUCTURE-BORNE NOISE
– REDUCTION OF THE AIR-BORNE NOISE
AND ITS TRANSMISSION TO THE SURROUNDINGS**

The dBlue system features three-layer pipes. Three different material centres get in the way of travelling airborne noise. They partially absorb sound waves, reflect them inwards and transfer significantly reduced noise to an environment. The absorbed and reflected waves make pipes and fittings comprising the waste system resonate acoustically. The resonance (Fig. 5), dynamically growing with the flow of the waste, is transferred via the bracketing system (brackets) onto the structure of the building. Construction barriers – subject to the transmission of the acoustic resonance – transfer it to adjacent rooms as sound waves. The design of the dBlue system along with dedicated brackets makes for the maximum reduction of this acoustic phenomenon (Fig. 4). National standards for the acoustic safety of buildings set forth the level of permissible noise in rooms such as a living room, a hospital ward, a bedroom or a hotel room. This is why it is these places that are notably protected against the structure-borne noise in the process of developing the design and acoustic documentation. Rooms through which run vertical stacks are most often exposed to airborne noise. It is also in these rooms that solutions fulfilling permissible noise standards need to be applied during the design works stage.

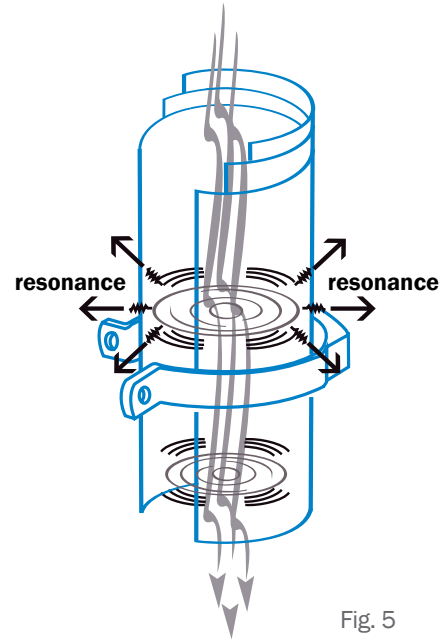

Fig. 5

16dB

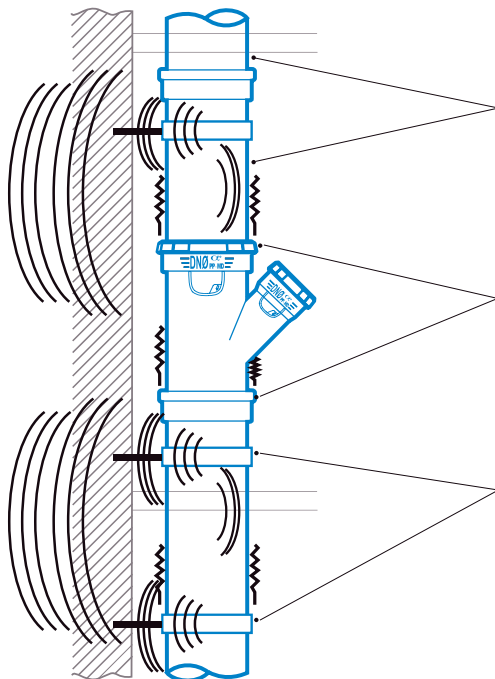

Fig.4

**dBlue SYSTEM OF PIPES AND FITTINGS
LIMITING THE PROPAGATION OF NOISE**

- three-layer structure of walls
- special material formula

**METHOD OF CONNECTING ELEMENTS
PREVENTS THE TRANSFERRING OF ACOUSTIC VIBRATIONS**

- tight connection of socket/seal between pipes and fittings

ACOUSTIC BRACKETING

- programme of dedicated acoustic brackets Phonoklip

In the independent testing of reduction of noise coming from waste installations and carried out by the Fraunhofer Institute for Building Physics, the dBlue system in the test conditions showed a transmission of noise at a very low level of 16 dB at flow $Q_{ww1} = 4$ l/s and 10 dB at $Q_{ww2} = 2$ l/s.

Table 4

MEASUREMENT OF STRUCTURE-BORNE NOISE – METHODOLOGY
FRAUNHOFER INSTITUTE REPORT

Measurements of structure-borne noise emission of the dBlue acoustic system were carried out in conformity with European standard EN 14366 "Laboratory measurement of noise from waste water installations".

The tests were carried out using two types of acoustic brackets:

- dBlue bracket (steel with a rubber lining to dampen the structure-borne noise vibrations)
- Phonoklip (with a cushioning section)

Measurement of the structure-borne noise in the dBlue system installation and the methodology are presented in the following diagram (Fig. 6 and 7). The test stand and diameters as well as types of components used are specified in the afore-mentioned standard as well as standardized [specimen] measuring stand. Water is the tested medium used in the test; it is introduced into the system on NK(f) floor and received on C floor. The acoustic tests (measurements) are carried out in PP(t) and PP(f) rooms; for comparative analysis with other acoustic systems or permissible standards in the construction industry, the least favourable boundary conditions are

taken, such as:

- maximum measurement flow rates in the soil and waste system:
 - (1) $Q_{ww1}=2,0$ l/s (maximum stabilised unit flow rate from a flush),
 - (2) $Q_{ww2}=4,0$ l/s (the most common maximum flow rate in a vertical stack DN 110),
- vertical stack diameter DN 110 (the most common maximum),
- measurement taken on the lowest floor in PP(t) room – room marked red in the diagram; in this place (in a room adjacent to the vertical stack) safety regulations specify and require the lowest levels of structure-borne noise,
- installation wall – lime stone, plastered, weight 220 kg/m² (the lightest type of a mounting wall onto which a soil and waste system inside a building can be installed).

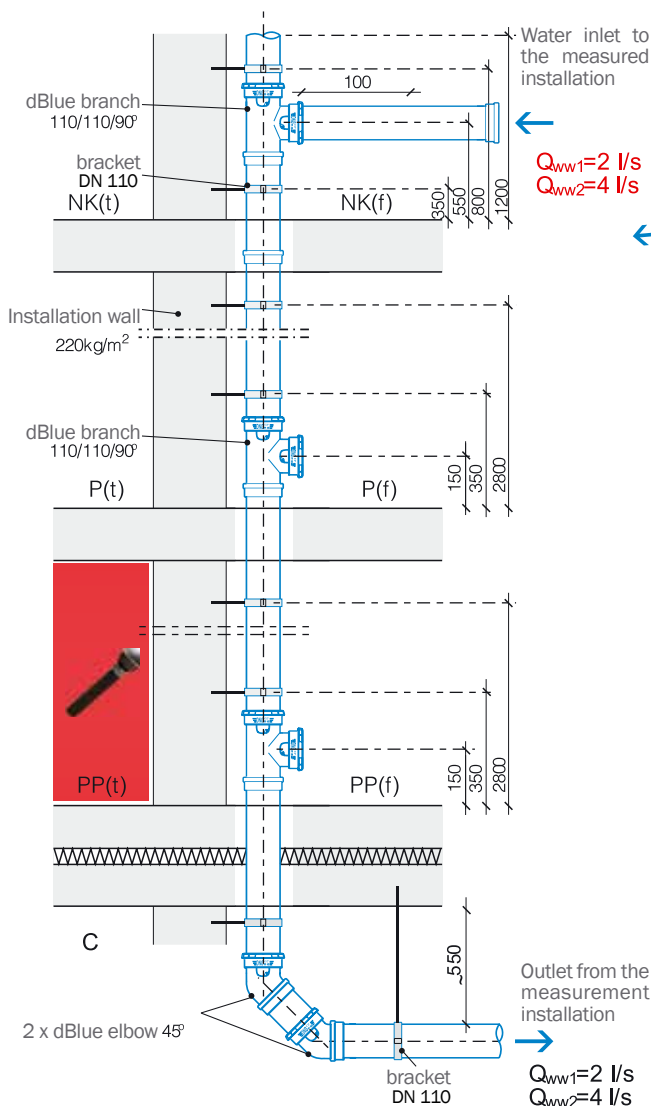

Fig. 6

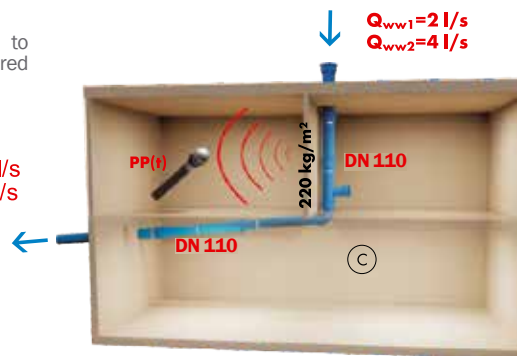

Fig. 7

NOTES:

- NK - highest floor
- P - ground floor
- PP - measurement room
- f - front
- t - rear
- C - basement / garage

Diagram (Fig. 8) summarises and visually presents noise measurement for dBlue soil and waste system carried out in the least favourable boundary conditions. Taking into account the assumptions of the above-mentioned test procedure (PN-EN 14366) the maximum levels of noise of dBlue installation were compared for the two most important flow rates.

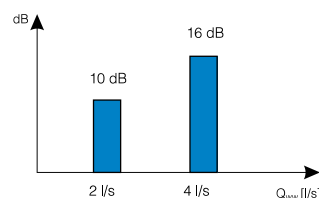

Fig. 8

MEASUREMENT OF AIR-BORNE NOISE ACOUSTIC FITTINGS

AIR-BORNE NOISE AT CHANGE OF DIRECTION

Tests and measurements of air-borne noise emission in a horizontal dBlue installation were carried out in conformity with the presented measurement scheme (Fig. 9).

Since standard PN EN 14366 does not set forth the methodology of air-borne noise measurement of horizontal sections, the scheme and the test configuration reflect the real installation in a building facility where the horizontal section runs through a room featuring a mandatory permissible level of noise (Photo 6).

AIR-BORNE NOISE IN A HORIZONTAL SECTION

The effect of air-borne noise reduction in a horizontal section of the installation can be achieved by:

- removing section acoustic sources thanks to a spot acoustic absorption (acoustic collar),
- directly insulating the installation's horizontal sections,
- applying insulation surfaces acoustically walling off the installation's horizontal sections [suspended ceiling].

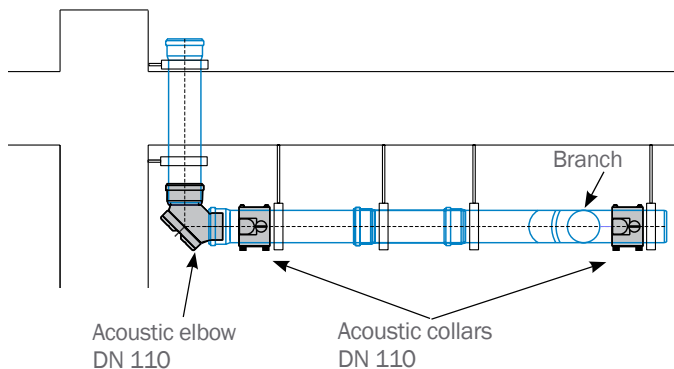

Fig. 9

ACOUSTIC ELBOW (inspection elbow) **DN 110** - consists of a body, an absorbing acoustic rubber lining and an inspection hatch. The operating principle consists in muffling the waste noise during the change of direction of the waste flow from vertical to horizontal. The noise is reduced thanks to a specially profiled lining located in the elbow that takes over and absorbs the energy of the flowing waste reducing the acoustic vibrations of the entire stack ie the effect of acoustic waves being reflected up the stack. Upon unscrewing the cap and removing the rubber lining the elbow may function as an inspection piece of the horizontal section (Photo 7).



Photo 7 Acoustic elbow



Photo 6 Measurement of the air-borne noise

Acoustic collar DN 110 - consists of a body closed with two screws in an elastic system. The collar is equipped with an acoustic membrane filling in - upon installation - the space between the body and the pipeline. In such a system, during the flow of waste, the membrane absorbs sound waves emitted from the pipeline causing a spot dampening of the air-borne noise (Photo 8).



Photo 8 Acoustic collar

In the presented test emission of the air-borne noise of a section of the dBlue installation with acoustic fittings installed on it the following was measured: acoustic elbow and collar, absorbing vibrations and acoustic waves.

MEASUREMENT OF AIR-BORNE NOISE – TEST REPORT METHODOLOGY

REDUCTION OF AIR-BORNE NOISE – LABORATORY TESTS

The measurement test was carried out on a horizontal section fitted with an acoustic elbow and acoustic collars. dBlue pipes and fittings of diameter DN 110 were tested. The following flow rates were applied for the measurement of air-borne noise reduction, similar to the methodology of standard PN EN 14366,:

- $Q_{ww1} = 2,0$ l/s – stabilised, single flow in a stack from a flushing unit – (Fig. 10).
- $Q_{ww2} = 4,0$ l/s – the most common maximum flow in a DN 110 stack.

The measurement of emission of the air-borne noise was carried out on the lowest measurement floor C*. To carry out the testing of the air-borne noise the same measuring tools as those used in the tests of the structure-borne noise (Fraunhofer) were used. The acoustic result is the weighted average result from a series of measurements.

The acoustic elbow was installed at a point of change of direction of the flow of waste from vertical to horizontal. Acoustic collars were installed on the horizontal section absorbing noise and acoustic vibrations in specific spots during the flow of waste. They were located directly behind the acoustic elbow and behind the connection (branch) of the neighbouring vertical stack to the tested horizontal outflow section.

The test was aimed at establishing the level of reduction of noise emitted in a room where the installation runs horizontally. These days it is a very frequent configuration on the lowest floors of buildings where conference rooms or restaurants are located and they require standard-guaranteed level of acoustics.

The test results show and compare the level of air-borne noise reduction on:

- an installation without acoustic fittings,
- an installation fitted with an acoustic elbow and acoustic collars.

The results of the test for the dBlue system installed in a building in accordance with the above-mentioned assumptions are presented in chapter “Acoustic Characteristics – dBlue system test results”. Because in the case of air-borne noise one refers to higher values [dB] of the measured noise while presenting the results of the test one uses the value of air-borne noise reduction by a given value [dB]. The methodology of the air-borne noise measurement provides for the measurement on a horizontal section of the dBlue installation without acoustic fittings and on the same installation but fitted with an acoustic elbow and acoustic collars mounted on the pipes. The difference in values [dB] between the two options and for two flows results in the above-mentioned value of reduction by a [dB] value.

The test follows the guidelines of PN EN 14366 standard “Laboratory measurement of noise from waste water installations”.

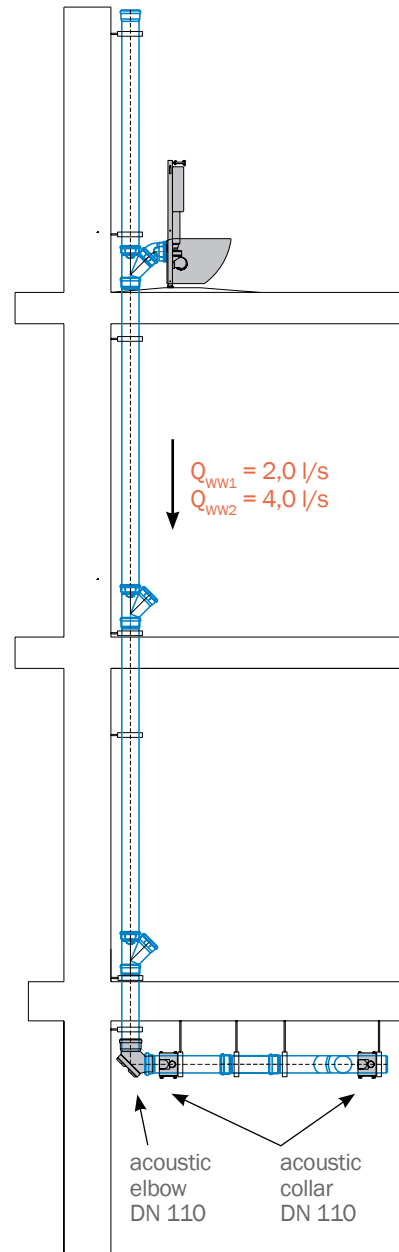

Fig. 10

*C - cellar



Designing and choosing an acoustic soil and waste system in the light of the achieved results and acoustic tests. Sequence of actions:

- first of all, establish the permissible levels of noise that will apply in particular areas (acoustic map of the building)
- knowledgeable about these areas carry out the acoustic balance and choose the installation systems so that the levels of noise permitted by the standards be fulfilled
- prior to choosing an acoustic soil and waste system check its noise-attenuation properties, not only of the structure-borne noise but also the air-borne noise
- while checking the acoustic characteristics of the selected acoustic system compare the results of noise reduction at the following flows
 - $Q_{ww1} = 2$ l/s (stabilised, single flow from a flushing unit – usually at night time)
 - $Q_{ww2} = 4$ l/s (stabilised maximum flow in a DN 110 stack – usually in the evening 07:00 pm – 08:00 pm, or in the morning 07:00 am – 08:00 am)

Table 5

**ACOUSTIC CHARACTERISTICS
– dBlue SYSTEM TEST RESULTS**

STRUCTURE-BORNE NOISE – ACOUSTIC TEST

It was carried out in the Fraunhofer Institute for Building Physics in Stuttgart (Photo 9) that holds the EU notification for carrying out tests of installation noise level in accordance with PN EN 14366 “Laboratory measurement of noise from waste water installations”.



Photo 9

**TEST USING PHONOKLIP BRACKET
TESTING ASSUMPTIONS**

- DN 110 brackets featuring a section absorbing acoustic vibrations
- DN 110 pipes and fittings – dBlue
- characteristic flows $Q_{ww} = 0.5; 1.0; 2.0; 4.0$ l/s
- installation wall – sand-lime brick 220 kg/m
- measurement taken on the lowest floor

Table 6

Flow rate, l/s	dBlue soil and waste system with acoustically insulating brackets “Phonoklip”			
	0,5	1,0	2,0	4,0
Airborne sound pressure level A; $L_{a,A}$ dB(A) ¹⁾	45	47	50	52
Structure-borne sound pressure level A; L_{SCA} dB(A) ¹⁾	<10	<10	10	16

1) set in accordance with PN=EN 14366:2006 standard

**TEST USING dBlue BRACKET
TESTING ASSUMPTIONS**

- DN 110 steel brackets with a dampening lining
- DN 110 pipes and fittings – dBlue
- characteristic flows $Q_{ww} = 0.5; 1.0; 2.0; 4.0$ l/s
- installation wall – sand-lime brick 220 kg/m²
- measurement taken on the lowest floor

Table 7

Flow rate, l/s	dBlue soil and waste system with acoustically insulating brackets dBlue			
	0,5	1,0	2,0	4,0
Airborne sound pressure level A; $L_{a,A}$ dB(A) ¹⁾	49	50	51	54
Structure-borne sound pressure level A; L_{SCA} dB(A) ¹⁾	14	16	16	18

1) set in accordance with PN=EN 14366:2006 standard

AIRBORNE NOISE – ACOUSTIC TEST

It was carried out in the Institute of Acoustics of Aliaxis R&D in Vernouillet (Photo 10). Laboratory measurements of the airborne noise from a soil and waste installation – horizontal section of the outflow. The test was carried out on the basis of PN EN 14366 methodology.



Photo10

**TEST USING ACOUSTIC FITTINGS
TESTING ASSUMPTIONS**

- DN 110 acoustic elbow with an amortizing lining
- DN 110 acoustic collar with an amortizing section
- DN 110 pipes and fittings – dBlue
- characteristic flows $Q_{ww} = 2.0; 4.0$ l/s
- installation wall – sand-lime brick 220 kg/m²
- measurement taken on the lowest floor

Table 8

Flow rate, l/s	dBlue soil and waste system with an acoustic elbow and acoustic collars	
	2,0	4,0
Noise level reduction directly by the value of air-borne sounds A; $L_{a,A}$ dB(A)	Reduction by 6,6 dB	Reduction by 5,9 dB

Innovative and Professional Acoustic System

NEW GENERATION dB^{blue} 16dB



DESIGN OF the dB^{blue} PIPE – 3 LAYERS

CONCEPT AND TECHNICAL PROPERTIES OF THE PRODUCT

RESEARCH

The objective of the dBlue project was to develop a complete system of pipes, fittings and brackets to ensure high noise attenuation, the best in class acoustic result and favourable economic balance of costs. dBlue is the first Polish acoustic soil and waste system developed by Nicoll in cooperation with the Aliaxis R&D Institute. As the so-called new approach system it features an innovative design of layers, a new material formula, optimum weight of elements as well as a number of useful features unseen in thick-walled systems (the so-called old approach) or other soil and waste systems.



Photo 11

The dBlue acoustic soil and waste system has been produced since 2006. Nicoll Polska, as the only Polish producer of an acoustic soil and waste system, has spared no effort to improve and modernize its product ever since. The past 7 years have seen continuous work on bringing innovations to the system and fitting it with new unusual functional properties. The new value of noise reduction predominates all of these properties. Now, the maximum level of noise of the dBlue system is 16 dB.

Thanks to implementing new elements and technical solutions dBlue also gained new applications and areas of use:

- an acoustic system of one of the best acoustic characteristics in its class (16 dB),
- an acoustic system that can be used as a complete gravitational rainwater drainage system,
- soil and waste system of maximum diameter of DN 200,
- soil and waste system for high-rise buildings.

dBlue also offers a lot of technical and practical features that definitely make it stand out against the competition. Nowadays, the dBlue system is even quieter.

MATERIAL FORMULA

– MODIFIED POLYPROPYLENE

For the purposes of the dBlue system a special material formula was developed combining materials and minerals (mineral filler); thanks to this noise emission was reduced and mechanical properties were enhanced. Prior to achieving the correct result detailed chemical tests and meticulous selection of raw materials comprising the material formula of the three-layer dBlue system were carried out. This process made dBlue not only evacuate waste safely and quickly but also helped reduce noise coming from its flow in the pipeline. Thanks to its additional advantages dBlue can be installed both indoors and outdoors (in the ground). On the one hand, the dBlue system is resistant to the flow of waste of very high temperatures; on the other hand, it can be installed in extremely low temperatures – in winter. During the works on the system it was decided to differentiate all the three layers making up the pipe with a different colour – depending on the material used in their production.



Photo 12



Photo 13

STRUCTURE OF THE dBlue PIPE - THREE LAYERS

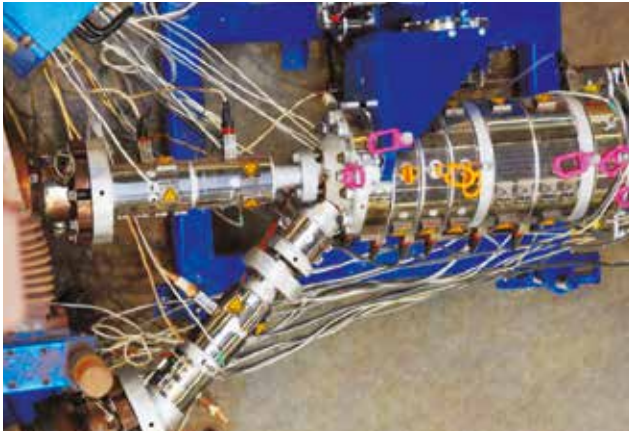

Photo 14. dBlue - three-layer co-extrusion

The state-of-the-art method of co-extrusion of modified polypropylene three-layer pipes is used in the production of the dBlue system (Photo 14). It is a co-extrusion process and permanent combination of three types of polypropylene. Thanks to the process waste flowing through the pipeline comes across three different layers ie physical centres, thus not only extremely reducing the propagation of the airborne noise but also posing resistance to a specific composition and temperature of the waste as well as external factors. In addition, the dBlue pipe boasts increased impact resistance and higher ring stiffness (min. SN4) and may be installed:

- in a building (supply, stacks, outflow sections),
- in the ground within the building's outline,
- as an underslab system.

EACH OF THE THREE LAYERS MAKING UP THE dBlue SYSTEM IS INDIVIDUALLY RESPONSIBLE FOR ITS TASKS

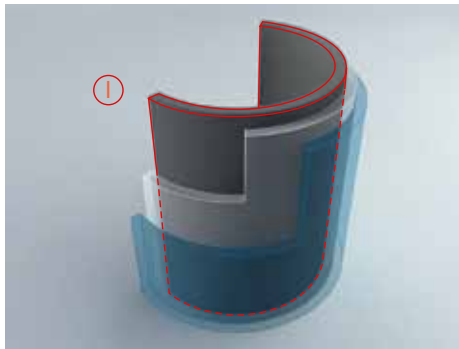

Photo 15

INTERNAL LAYER [I]

- material: PP-B polypropylene with flame retardant
- colour [grey]
- resistant to high temperature +90 °C [+95 °C]
- high chemical resistance
- smooth surface

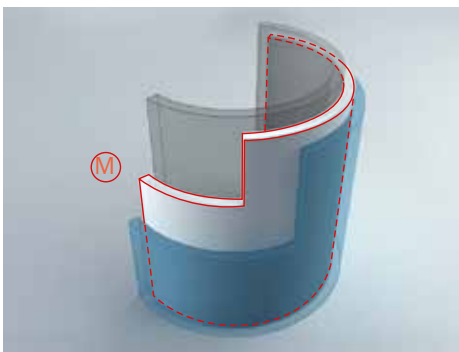

Photo16

MIDDLE LAYER [M]

- material: PP-H modified polypropylene
- additionally reinforced with minerals
- noise reduction
- high stiffness

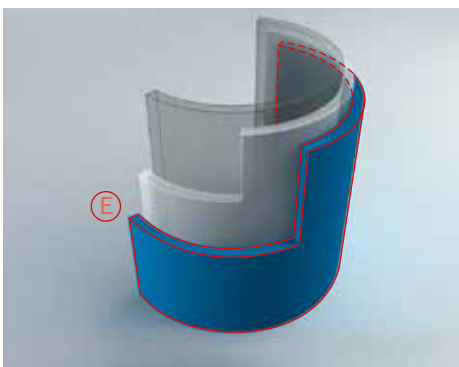

Photo17

EXTERNAL LAYER [E]

- material: PP-B polypropylene
- colour [blue]
- resistance to external tensions
- resistance to atmospheric factors
- smooth surface

**STRUCTURE OF dBlue FITTING
- COMPACT WALL**

The new generation of dBlue acoustic fittings combines many unique technical and practical properties. The fittings are produced in a compact version and are classified as products of high area of mechanical resistance.



Photo 18

STRUCTURE OF dBlue ACOUSTIC BRACKETS

PHONOKLIP - 16dB

dBlue Bracket - 18dB

Full range of diameters:
Ø 40 / Ø 50 / Ø 75 /
Ø 90 / Ø 110 / Ø 125 /
Ø 160 / Ø 200

Easy to close and mount

Full range of diameters:
Ø 40 / Ø 50 / Ø 75 /
Ø 90 / Ø 110 / Ø 125 /
Ø 160 / Ø 200

Section absorbing acoustic vibrations

Stable fastening to the construction of a building

Dampening lining across the entire perimeter of the bracket

Stable fastening M10

Photo 19

Photo 20



dB *Blue*
ACOUSTIC
SYSTEM

PLANNING AND DESIGN GUIDELINES
SOIL AND WASTE SYSTEM

ACOUSTIC PROFILE OF A BUILDING

Prior to mapping out the pipe lines, the location of stacks and the capacity of the installation one should analyse the profile and acoustic "map" of the designed building.

Knowing the functions of particular rooms and the level of permissible noise in them it is easy to establish their acoustic standard. The designed technical equipment in the tested and adjacent rooms will establish the sources of noise, allow their analysis and selection of alternative solutions aimed at obtaining the planned acoustic standard resulting from the map. Stage two requires carrying out hydraulic calculations of the project.

GENERAL BALANCE OF WASTE

Developing the balance requires setting the value of calculation flows in particular sections of the installation in order to properly size the diameters of downpipes as well as diameters and slopes of outlet pipe lines.

A soil and waste system properly designed should ensure a safe, efficient and odourless discharge of household (sanitary) waste and rainwater from the building.

HOUSEHOLD WASTE BALANCE

According to PN-EN 12056 - "Gravity drainage systems inside buildings. Part 2: Sanitary pipework, Layout and calculation" the balance is calculated on the basis of the following formula:

$$Q_{ww} = K \sqrt{\sum DU}$$

Q_{ww} - waste flow rate (l/s)

K - frequency rate dependent on the building's application (Tab. 9)

DU - sum of unit outlets dependent on the type of appliances (Tab. 10)

Having calculated the flow rates it is necessary – on the basis of their value and PN-EN 12056 - 2 standard guidelines – to size diameters and slopes of pipe lines. For downpipes the diameters need to be sized so as to ensure the proper efficiency and ventilation during the waste discharge process.

Table 9

Use of appliances – ratio	K
Discontinuous use, e.g. flat, guesthouse, office	0,5
Seasonal use, e.g. hospitals, schools, dormitories	0,7
Collective use, e.g. public toilets and showers	1,0
Special use, e.g. laboratories	1,2

Table 10

Appliances	System I DU [l/s]
Sink, bidet	0,5
Shower without a stopper	0,6
Shower with a stopper	0,8
Single urinal with a tank	0,8
Urinal with a flushing valve	0,5
Bath	0,8

Cont. Table 10

Kitchen sink	0,8
Dishwasher (household)	0,8
Automatic washing machine up to 5 kg	0,8
Automatic washing machine up to 12 kg	1,5
Flush toilet with a tank 6.0 l	2,0
Floor drain DN 50	0,8
Floor drain DN 110	2,0

RAINWATER BALANCE

According to PN-EN 12056 - "Gravity drainage systems inside buildings. Part 3: Roof drainage, layout and calculation" when working out the rainwater balance, first, the roof has to be divided into sections from which rainwater will be drained. Next, knowing the dimensions and surface of each section, one needs to calculate the maximum flow rate using the following formula:

$$Q_D = r A C$$

Q_D - rainwater flow rate (l/s)

r - measurable rainfall intensity (l/s ha) = 300 l/s ha (roofs)

A - roof area to be drained (m²)

C - flow ratio (1.0 unless otherwise specified in national regulations)

The specified flow Q_D and the following table (Capacity of vertical drain pipes, Tab. 11) allow for the sizing of diameters of rainwater stacks along with specifying their maximum capacity Q_{RWP}

Table 11

Internal diameter of a drain pipe d_n [mm]	Capacity Q_{RWP} for the level of filling $f=0,33$ [l/s]*	Capacity Q_{RWP} for the level of filling $f=0,2$ [l/s]
50	1,7	0,7
75	5,0	2,2
90	8,1	3,5
110	13,8	6,0
130	21,6	9,4
160	37,5	16,3
200	68,0	29,5

*PN-EN 12056 standard: Part 3 recommends applying $f=0.33$ provided that the national regulations and guidelines do not specify the use of a different level of filling.

Knowing the maximum flow rate, capacity of the stack and its diameter, roof drains need to be selected on the basis of its nominal capacity (l/s) and the type (roof type, covering).

SOIL AND WASTE SYSTEM PLANNING AND DESIGN GUIDELINES

PROJECT

INSTALLATION – COMPLIANCE WITH THE STANDARD, FUNCTION AND STANDARD OF THE DESIGNED BUILDING

Following an acoustic analysis, hydraulic calculations, sizing diameters and slopes as well as location of stacks each design of a soil and waste system comprises a complete system for waste discharge. At this stage the designed building along with the soil and waste system should be analysed in terms of expected technical parameters as well as product solutions and systems ensuring them in particular areas (sections).

The selected systems should comply with the applicable regulations and standards as well as the planned function and standard of the building, especially in terms of acoustic characteristics and safety of use.

This requires assessing:

- the type of waste and location of its discharge from a building,
- the height of stacks and the amount of waste and its speed in the stacks,
- the location of stacks (which sections of the building)
- the normative requirements on the safety in the above-mentioned areas, especially requirements regarding the permissible levels of noise and fire regulations.

Such an analysis will make for a comprehensive selection of a soil and waste system featuring the properties and parameters complying with all the afore-mentioned standards in the building.

IDENTIFICATION OF KEY AREAS AND APPLIED TECHNICAL EQUIPMENT OF THE BUILDING

The following planning example (Fig. 11) highlights areas (sections) of the soil and waste system in a residential and commercial building.

Their analysis and solutions are based on the above-mentioned assumptions allowing for a selection of proper solutions.

Key:

Section – an area of a building encompassing a fragment of the installation and applicable requirements

PD – Rainwater Stack

PS – Sanitary Stack

PW – Ventilation Stack

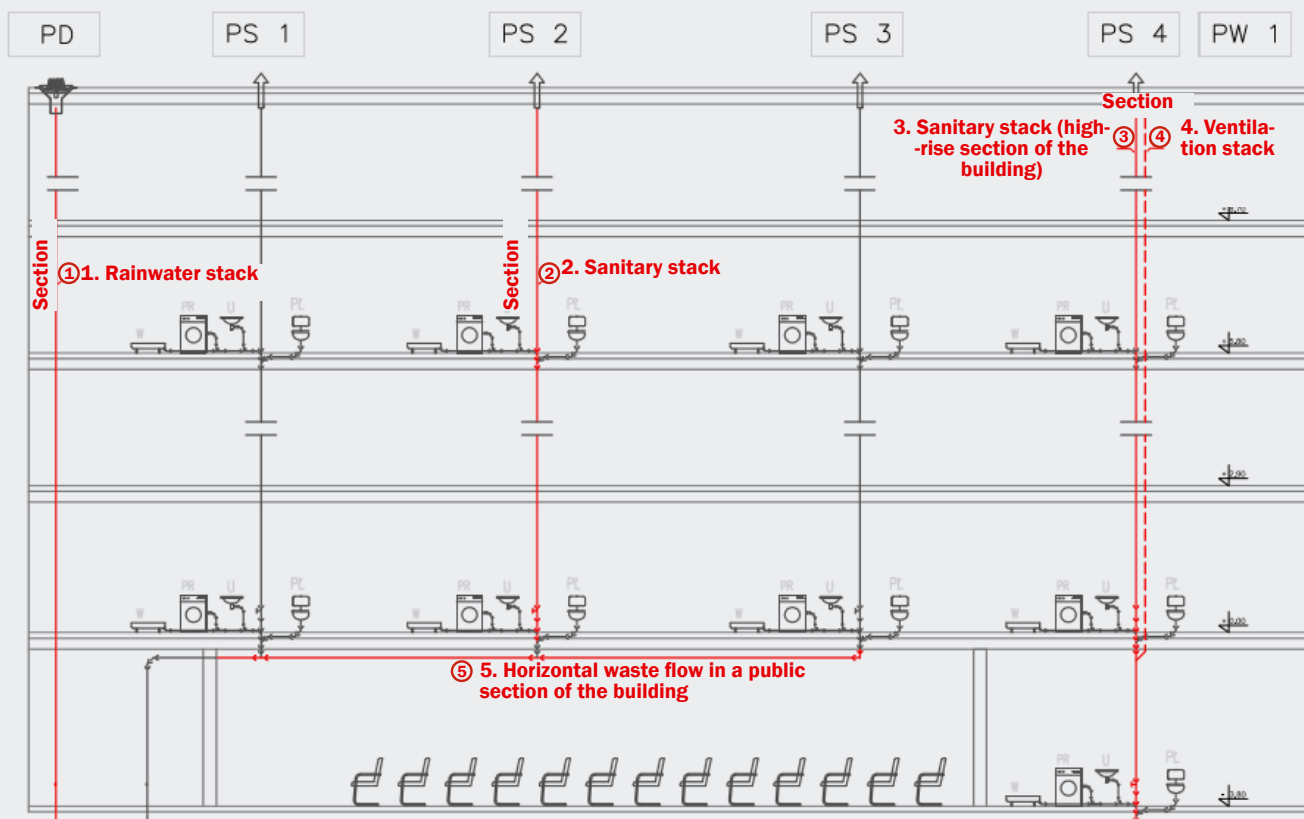

Fig. 11

SOIL AND WASTE SYSTEM PLANNING AND DESIGN GUIDELINES

PROJECT – SECTION 1
RAINWATER- GRAVITATIONAL STACK

dBlue system makes up a complete system of gravitational rainwater system in a building. The system includes:

ALUTEC ROOF OUTLETS (Photo 21):

- made from non-corrosive materials (heavy grade cast aluminium and steel),
- fit for all kinds of constructions and roof coverings (bituminous/plastic),
- fitted with outflows of dimensions DN 110 and DN 160 in a vertical and horizontal set-up,
- capacity of 12.8 and 14.4 l/s respectively.



Photo 21

dBlue COMPLETE ACOUSTIC SOIL & WASTE SYSTEM (Photo 22):

- comprehensive range in: DN 40, 50, 75, 90, 110, 125, 160, 200,
- including a vast range of pipes and fittings,
- excellent noise-attenuation parameters (maximum installation noise level – 16 dB),
- made from materials featuring very high mechanical resistance,
- boasting outstanding tightness of connections and smoothness of internal walls.



Photo 22

TIGHTENING CLAMPS SYSTEM(Photo 23):

- strengthening socket connections, ensuring tightness of the system the moment the stacks are filled,
- protecting the installation against internal pressure ($P_{max} = 2,5$ bar),
- made of non-corrosive material,
- dismantling-friendly in case of inspection.



Photo 23

CHOOSING dBlue AS A RAINWATER-GRAVITATIONAL SYSTEM

The choice is described in chapter “Rainwater Balance”. For assistance the following table includes a practical selection of rainwater stacks based on systematic values of roof area (f = 0.33 applied).

Table 12

Roof area [m ²]	Q _D [l/s]	dBlue dimension of drain pipe [mm]	Q _{Dmax} (drain pipe / inlet) [l/s]	Number of drain pipes / roof outlets	Type of roof outlet
50	1,5	110	13,8 / 12,8	1 / 1	DR410
100	3	110	13,8 / 12,8	1 / 1	DR410
150	4,5	110	13,8 / 12,8	1 / 1	DR410
200	6	110	13,8 / 12,8	1 / 1	DR410
500	15	110	13,8 / 12,8	2 / 2	DR410
1000	30	160	37,5 / 13,4	3 / 3	DR610

Such a selection of stacks will ensure a safe and quiet way of gravitational discharge of rainwater from the buildings’ roofs.

SOIL AND WASTE SYSTEM PLANNING AND DESIGN GUIDELINES

PROJECT – SECTION 2 SANITARY WASTE STACK

SANITARY ACOUSTIC SOIL&WASTE SYSTEM. STRUCTURE-BORNE NOISE REDUCTION.

Provided that the analysed building is a residential building with a public service function regulations of the Building Law on the permissible noise level in residential spaces will apply.

A standard soil & waste system does not ensure efficient acoustic protection and features a high level of noise coming from waste water installations exceeding 35 dB at a flow rate of 4 l/s and above 25 dB at a flow rate of 2 l/s.

In this case only an acoustic soil and waste system provides compliance with the standards and acoustic comfort.

ACOUSTIC dBlue SYSTEM ACOUSTIC PROPERTIES

- a high level of noise attenuation guaranteeing maximum installation noise in stacks at:
10 dB przy $Q_{ww1} = 2$ l/s
(maximum stabilised unit flow – a single flush unit)
16 dB przy $Q_{ww2} = 4$ l/s
(stabilised maximum collective flow in a stack DN 110).

TECHNICAL PROPERTIES:

- vast range of pipes and fittings DN 40, 50, 75, 90, 110, 125, 160, and 200,
- professional product programme [double branches and corner double branches; welded fittings and special fittings],
- resistance to high waste temperature +90°C (momentary +95°C),
- resistance to low ambient temperature, including installation possibility at below (-10°C),
- installation in high-rise buildings without the need of an additional ventilation stack or increasing the diameter of a stack (Akavent fitting),
- possibility of under-slab installation or in the ground within the building's outline.

Planning guidelines for the dBlue system as an acoustic soil and waste system are specified in chapter "Household Waste Balance".

PROJECT – SECTION 3 AND 4 STACKS IN HIGH-RISE BUILDINGS – A dBlue SYSTEM AKAVENT VENTILATION FITTING

HIGH-RISE BUILDINGS

Recently, high-rise construction has seen notable growth. Today's engineering makes for erecting high-rise buildings well over 100 metres high. Apart from their residential function high-rise buildings of today very often feature an office function alongside with a commercial surface.

A building or its part designed this way poses stringent requirements in terms of the quality and operation of all building elements used for its construction.

One of the most significant elements are installations including a soil and waste system. Its objective is to evacuate large amounts of waste from significant heights in a safe way in terms of hydraulics, construction and functionality.

HYDRAULIC PLUG

A large amount of waste at high speeds causes the so-called "hydraulic plug" in stacks (Fig. 12). The plug results in blocking a soil and waste stack due to air resistance in the stack faced by waste falling in large amounts and at a high speed.

Two types of pressure are generated at that moment in a stack: pressure before the hydraulic plug, negative pressure behind the plug and in connections to appliances.

Water protections (siphons) located above the plug are exposed to sucking out by negative pressure. Pressure in turn generates force on water protections located below and possibility of blowing. To date an increase in the stack diameter or planning a side ventilation stack have been used to prevent the aforementioned phenomenon.

Even though common and in compliance with the norm such solutions result in extra installation works increasing the total cost of the installation.



Photo 24

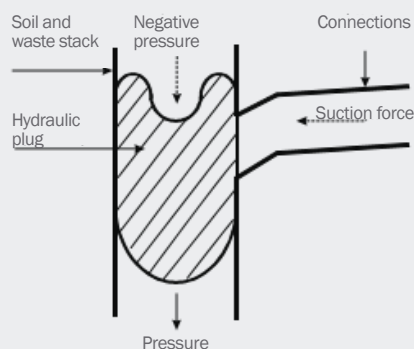

Fig. 12

SOIL AND WASTE SYSTEM PLANNING AND DESIGN GUIDELINES

TRADITIONAL STACKS

Optimal hydraulic capacity and full ventilation of the system are the foundations of planning soil and waste stacks. For waste not exceeding Q_{MAX} flowing through the stack, ventilation is provided by the main stack (Fig. 13).

If the planned flow rate is exceeded (e.g.: Q_{MAX} = 4 l/s or DN 110 stack), appropriate ventilation of stacks is achieved through: increasing its diameter (Fig. 13), side ventilation with an additional ventilation stack (Fig. 13).

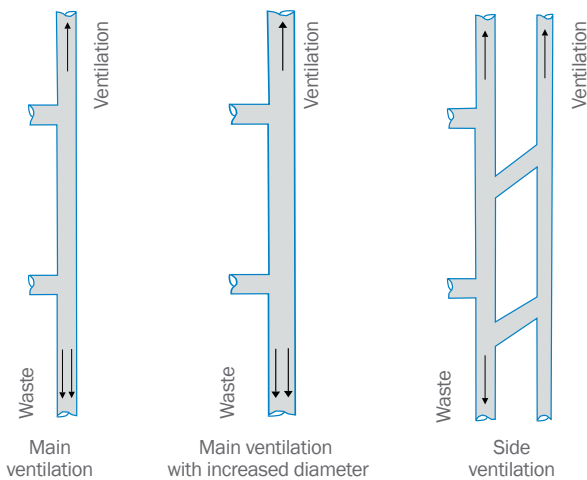

Fig. 13

AKAVENT FITTING – OPERATION

It is designed for high-rise buildings. Thanks to its construction it separates the main stream of waste flowing through the stack from waste coming in from side stacks; this prevents the occurrence of the so-called “hydraulic plug”. It has additional internal ventilation which balances pressure and ensures appropriate supply of air without the need of using increased diameter or additional ventilation stack.

Waste flowing through the fitting is diverted towards the walls of the arch thanks to which the velocity of the waste is reduced (Fig. 14).

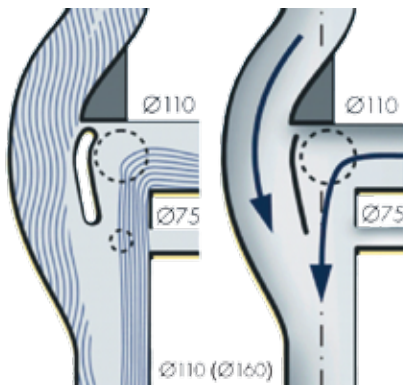

Fig. 14

AKAVENT FITTING – ADVANTAGES:

- it increases capacity of the stack up to Q_{MAX} = 7.6 l/s (traditional stack DN 110 – Q_{MAX} = 4,0 l/s),
- it prevents the “hydraulic plug”,
- thanks to its construction and additional ventilation it eliminates the necessity of increasing diameter of the stack and/or using additional ventilation stack,
- decreases the speed and energy of the flowing waste making for a technical offset pipe,
- possible connection of diameters DN 110 and DN 75 in one fitting (Fig. 15),
- available in diameters DN 110 and DN 160,
- secures water locks (siphons),
- saves installation space.

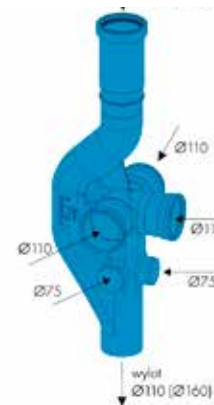

Fig. 15

AKAVENT – DESIGN GUIDELINES*

- hydraulic calculations (chapter: Household Waste Balance), in case of exceeding maximum flow in a stack use the Akavent fitting on connection floors,
- maximum distance between the Akavent fittings is h = 5 m (Fig. 16),
- in case the distance is bigger than 5 m, an additional element reducing the speed of waste should be installed (Fig. 16), the Akavent fitting features socket connections 3 x DN 110 and 3 x DN 75,
- on the lowest floor, at a transition of a stack into a horizontal outlet a ventilation bypass should be installed (Fig. 17).

NOTICE: Opposite lateral connections of the same diameter are not permitted

*detailed data for a specific design plan are prepared by the Nicoll Polska Technical Support office.

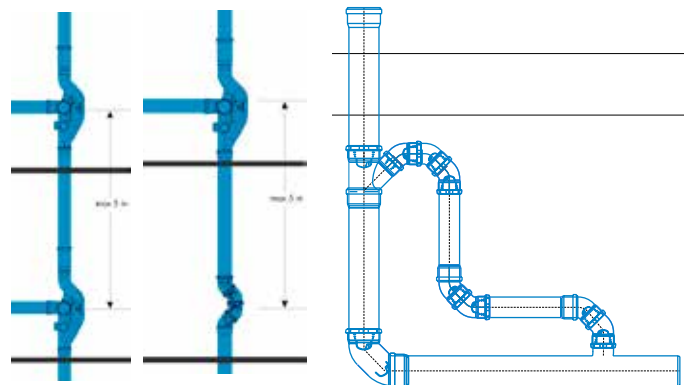

Fig. 17

SOIL AND WASTE SYSTEM PLANNING AND DESIGN GUIDELINES

PROJECT – SECTION 5

dBlue ACOUSTIC SOIL AND WASTE SYSTEM. ADDITIONAL PROTECTION AGAINST NOISE ON HORIZONTAL SECTIONS – AIR-BORNE NOISE.

Within the current planning practice, very often in parts of buildings where horizontal outflow sections are planned, their route is planned through rooms of functions requiring acoustic protection. These are usually lower and the lowest floors in a building with rooms featuring the following functions:

- conference
- commercial,
- cinema and culinary.

Regulations of the Building Law setting forth permissible noise levels apply to the aforementioned sections of buildings. The reduction of noise in such cases is achieved by:

- reducing the volume of the source of noise (reduction of dB),
- direct insulation of a pipe line (insulation of pipes and fittings),
- indirect insulation of a pipe line (through a suspended ceiling made of noise-absorbing materials).

Out of the afore-mentioned methods it is the effective reduction of the volume of the source that results in a noticeable change for the human's ear and comfort.

For horizontal sections of a soil and waste system, the biggest source of noise is the point of change of direction from vertical to horizontal (a bend on a stack) and the point of connecting other stacks or horizontal pipe lines. The acoustic dBlue soil and waste system boasts a programme of acoustic fittings reducing the air-borne noise at the source in the installation. These are:

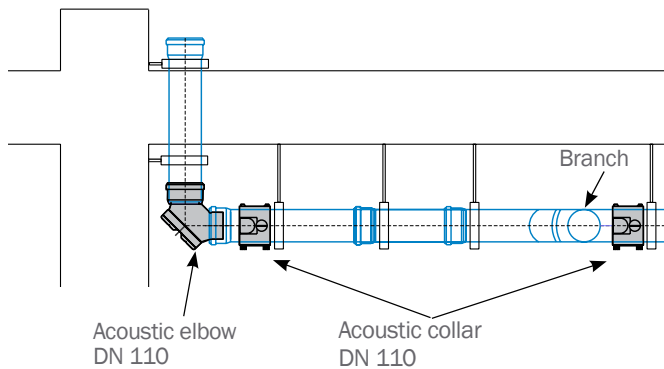

Fig. 18

ACOUSTIC ELBOW DN 110 with a profiled absorbing insert and inspection function. Located in the construction point (point of change of soil and waste flow from vertical to horizontal) it amortizes the energy and the flow of waste vertically thanks to the rubber profile. It is conducive to reducing noise across the room and eliminates the effect of reflecting acoustic vibrations up the stack (Fig. 18).

ACOUSTIC COLLAR DN 110 featuring a layer absorbing vibrations – provides a spot reduction of air-borne noise (sound waves). The layer locally absorbs the noise generated at the time of waste flow reducing noise of the entire system in stages. The noise absorption features are used by installing it on horizontal sections directly after the acoustic elbow (transition of a vertical stack to a horizontal section) and directly after each connection to the horizontal outflow section (Fig. 18).

ACOUSTIC ELBOW AND COLLAR

The use of both solutions results in reducing the acoustic level of the system i.e. in the noise reduction by:

- 6,6 dB przy $Q_{ww1} = 2$ l/s (stabilised unit flow in a stack coming from a flushing unit),
- 5,9 dB przy $Q_{ww2} = 4$ l/s (the most common maximum flow in a stack DN 110).

Averaging the two results it is possible to assume that the use of dBlue acoustic fittings on horizontal sections decreases the acoustic characteristic of the soil and waste system by 6 dB.

In the case of noise it is a significant improvement of the room's acoustic quality because – in line with chapter "Acoustics in the Construction Industry – Basic Terminology" – the sum of two identical sources of noise gives the value of one of them increased by 3 dB (e.g.: 16 dB + 16 dB = 19 dB).

At the moment of reducing a noise level by 6 dB [dBlue acoustic elbow and collar] the level of emitted noise is decreased substantially and in the above-described case one of the sources is reduced.

BRACKETING PLAN

1. BRACKETING PLAN – 16dB PHONOKLIP ACOUSTIC BRACKET (Fig. 19).

The following rules have to be observed:

- 1** 1. Distance between brackets in the vertical stack should not exceed 1 – 2 m
- 2** 2. Distance between brackets in a horizontal section should be:
 $L = 15 \times DN$ for diameters 40÷110 mm
 $L = 10 \times DN$ for diameters (125÷200mm)
- 3** 3. For each standard* floor two single Phonoklip brackets should be installed
- 4** 4. It is recommended that the upper bracket be installed as a guide point bracket
- 5** 5. It is recommended that the lower bracket be installed as an anchor point bracket

*standard floor h = 2.60 m

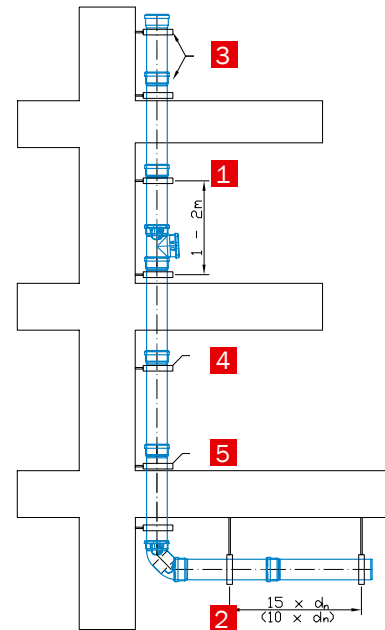

Fig. 19

2. BRACKETING PLAN – 18dB DBLUE ACOUSTIC BRACKET (Fig. 20).

The following rules have to be observed:

- 1** 1. Distance between brackets in the vertical stack should not exceed 1 – 2 m
- 2** 2. Distance between brackets in a horizontal section should be:
 $L = 15 \times DN$ diameters 40÷110 mm
 $L = 10 \times DN$ diameters (125÷200mm)
- 3** 3. It is recommended that the following bracketing set-up be used on every other floor starting from the ground floor:
 upper bracket – single (guide point bracket)/lower bracket – double
 It is recommended that the following bracketing set-up be used on the remaining floors: upper and lower bracket – single
- 4** 4. Upper bracket – single (guide point bracket)/lower bracket – single (anchor point bracket)
 - such a bracketing plan is alternate.

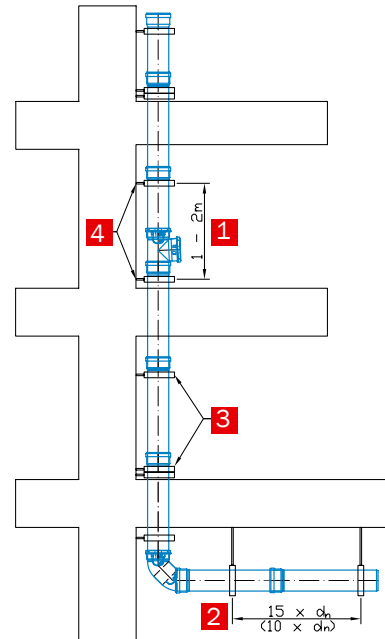

Fig. 20

In accordance with the technical specification, the producer's guidelines and Technical Approval AT-8742/2016 – the dBlue acoustic soil and waste system can be installed with the following types of brackets (fastening):
 Phonoklip noise-attenuating acoustic brackets (buildings of the highest acoustic quality),
 dBlue acoustic brackets (buildings of high acoustic quality),
 standard steel brackets with an elastomer insert (buildings of enhanced acoustic quality).
 Each plan of an acoustic system is developed for buildings of different construction and building systems and different acoustic standards. The choice of the system, the location of pipe lines, installation details including the type of brackets and bracketing plan should be consulted with the producer. This way a facility combining the intended function and construction as well as acoustic quality will be erected.



Table 13

PLANNING, LAY-OUT AND INSTALLATION OF ELEMENTS

3. INSTALLING dBlue PIPES AND FITTINGS IN ACOUSTIC BRACKETS. AN ANCHOR POINT BRACKET AND A GUIDE POINT BRACKET.

PHONOKLIP BRACKET

It comes with a system lock with a locking screw (M-6) and a spacer. In order to obtain a guide point bracket insert a pipe (fitting) in a bracket and lock it with a screw and a spacer (Fig. 21).

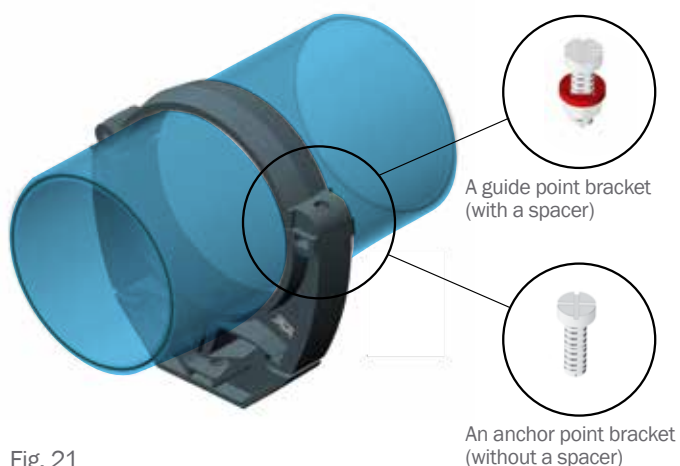

Fig. 21

In order to obtain an anchor point bracket remove the spacer from the locking screw prior to locking the bracket.

dBlue BRACKET

It comes with a system lock with a locking screw (M-6) and two spacers. In order to obtain a guide point bracket insert a pipe (fitting) in a bracket and lock it with a screw and two spacers (Fig. 22).

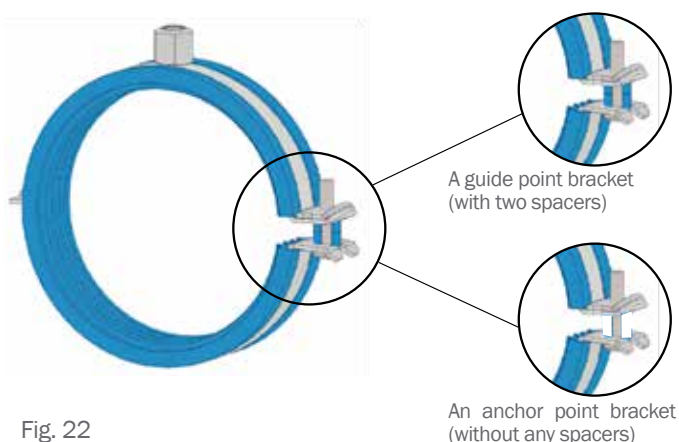

Fig. 22

In order to obtain an anchor point bracket remove the two spacers from the locking screw prior to locking the bracket.

4. PENETRATION THROUGH A CONSTRUCTION BARRIER (Fig. 23)

Insulating soil and waste ducts across construction barriers (Detail 'A') is an important part of the planning and design process. It is aimed at safeguarding the users against the so-called "acoustic bridges" in construction barriers. These are points where a duct being in contact with the construction of a building transfers acoustic vibrations generated by the flowing waste.

Detail "A" shows the correct penetration of an acoustic duct through a construction barrier. Each penetration should be secured with a sleeve (3 - 5 mm) made of material ensuring proper acoustic and moisture insulation.

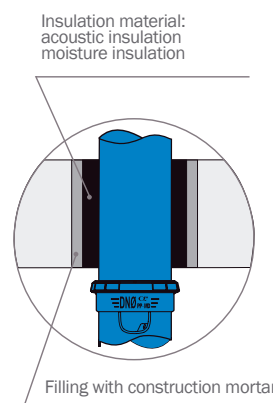

Fig. 23
Fig. 23 Detail "A"

5. STABILIZING SECTIONS

"Short" stabilising section.

For stacks up to 10 m it is recommended that the following be used for transitions from vertical to horizontal:

- stabilizing elbow,
- or two elbows 45°.

"Long" stabilising section.

For stacks over 10 m high it is recommended that a 240mm dBlue pipe be used between two 45° elbows (Fig. 24).

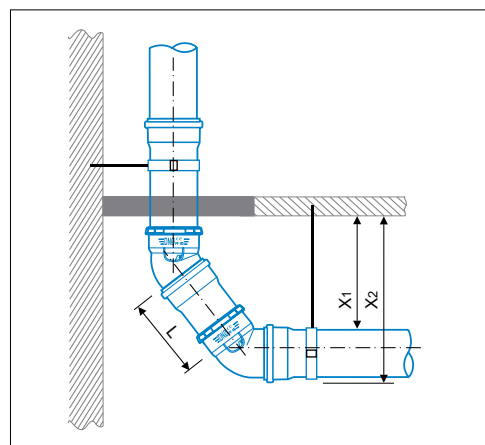

Fig. 24

Table 14

Length of a section L (mm)	Diameter of a pipe DN (mm)	Distance from the ceiling X ₁ (mm)	Distance from the ceiling X ₂ (mm)
240	110	160	270
240	160	160	325

PLANNING, LAY-OUT AND INSTALLATION OF ELEMENTS

6. STABILISING ACOUSTIC ELBOW WITH AN INSPECTION FUNCTION

The stabilising elbow mitigates the waste flow and smoothens the waste stream. This prevents the acoustic vibrations from being reflected up the stack. A special amortizing insert installed at a point of transition from vertical to horizontal makes this possible. In addition, the elbow improves acoustics in a room by approx. 6 dB. The elbow can be used for buildings with stacks over and below 10 m (Fig. 25).

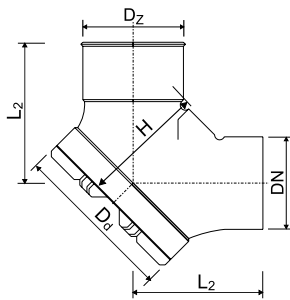

Fig. 25

7. EXPANSION SOCKET

An expansion socket should be planned for stacks installed on wooden constructions or in conditions where a stack is prone to expansion or contraction (Photo 25).

An expansion socket should be installed on a stack where an assumed compensation of the thermal expansion of the stack is higher than expansions resulting from changes in ambient temperature.



Photo 25

Photo 26

8. OFFSET PIPE*

In high-rise buildings over seven floors high (assuming that a standard floor height is $h = 2.6$ m) every 7-8 floors, starting from the highest stack point, so-called offset pipes can be installed in order to slow down the energy of the falling waste. The following offset pipes can be used for the dBlue acoustic system :

- "short" offset pipe,
- "long" offset pipe (with a stabilising section).

The following figure illustrates a sample configuration for a given diameter.

Fig. 26 "Long" and "short" offset pipe.

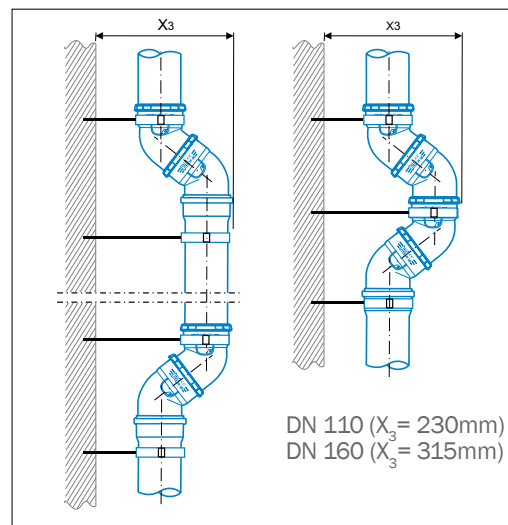

Fig. 26 "Long" and "short" offset pipe.

AKAVENT

By virtue of its shape and separating the main stream from the in-flowing stream, the Akavent fitting functions as an offset pipe (Photo 26). Apart from its numerous advantages it guarantees the reduction of the energy the flowing waste and slows down its speed.

*NOTE: The use of offset pipes is not governed by any standard and constitutes an arbitrary choice in the planning process.



PLANNING, LAY-OUT AND INSTALLATION OF ELEMENTS

9. HORIZONTAL CHANGE OF DIRECTION

Ensure gradual horizontal transitions are made using two 45° elbows to decrease noise levels compared to the use of a 90° elbow. Such a moderate change of flow direction reduces the energy of the flowing waste making the acoustic properties of the system even more efficient (Fig. 27 and 28).

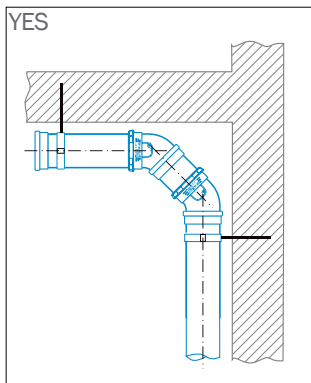

Fig. 27

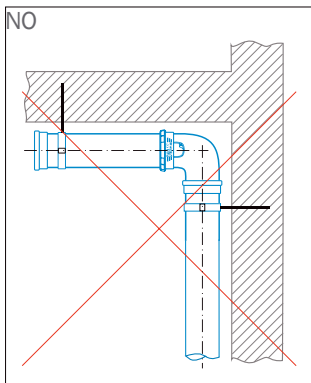

Fig. 28

10. FULL DIMENSIONAL STANDARDIZATION

With a view to an ease of installation works and connecting the dBlue system to other systems as well as connecting these systems to the dBlue system a full dimensional compliance with EN1451 was kept. This makes for standard connections in all diameters without the need of using adaptor fittings for nonstandard diameters. The dBlue system is fully compatible and can be connected to systems made of PP-HT, PVCu, PE, and cast iron. The following illustrate basic examples of connections.

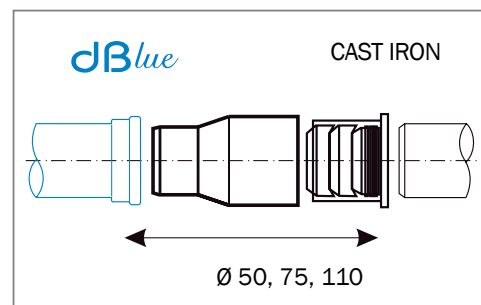
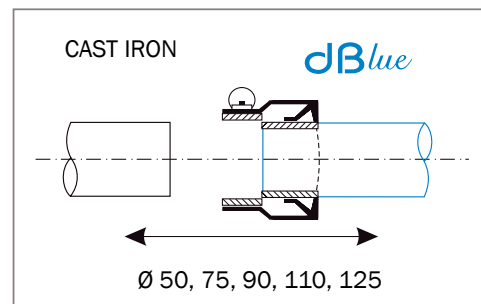
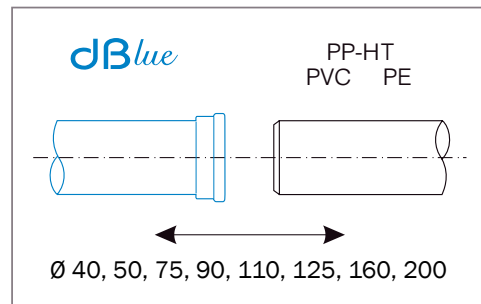
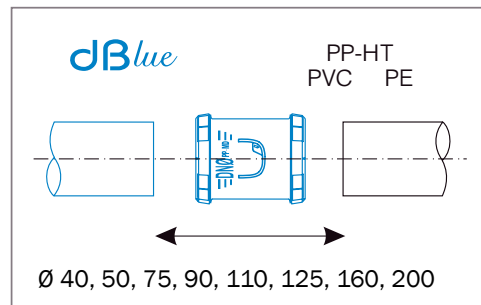

Fig. 29

DESIGN AND TECHNICAL SUPPORT

REVIT FILES LIBRARY

REVIT file library is an intuitive solution for construction engineers who wish to switch to a building information modelling system. At each stage of a design using REVIT files containing groups of fittings of the acoustic dBlue system, it is easy to present a 3D model of the designed installation. The generated building documentation is of higher quality, which helps decrease costly adjustments and eliminate the hassle of manual re-design. Moreover, 3D models can be used to prepare professional virtual visualizations of the designed facilities. The use of REVIT files in the design process makes for an easy and precise development of a list of materials used in the facility. It enhances the development of a bill of quantities and consequent cost estimate of the designed installation (Fig. 30).

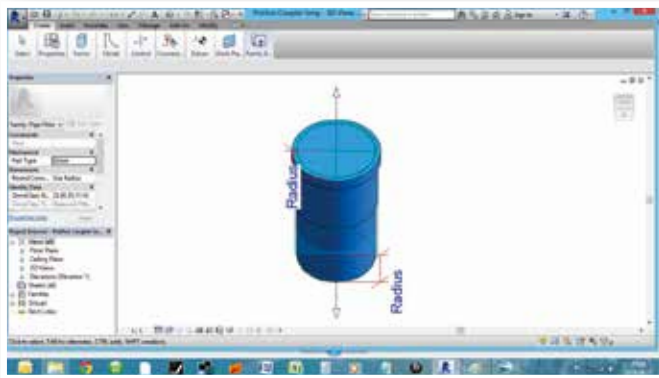

Fig. 30

AUTOCAD LIBRARY

Apart from REVIT files Nicoll Polska also introduced the AutoCAD library of the acoustic dBlue soil and waste system as part of its technical and design support. The drawings contain technical and dimensional details of fittings and precisely reflect their dimensions (Fig. 31 and 32).

The library was created in dwg format. The use of drawings of pipes and fittings helps precisely size the connections for offset pipes, the reducing ducts, changing directions, dimensioning of cushioning sections and shafts where the ducts and their joints are running.

dBlue Branch

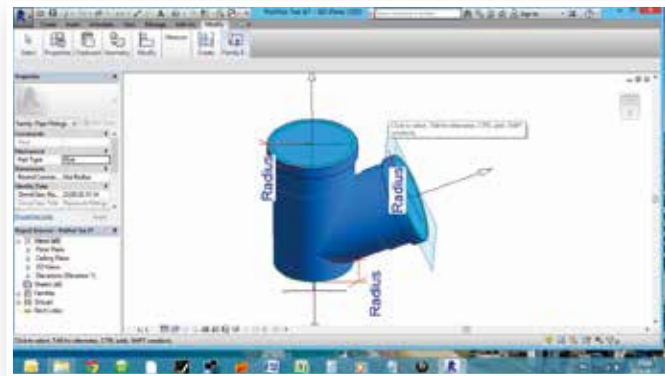

Fig. 31

dBlue Elbow



Fig. 32



CONFERENCES AND SEMINARS

Guidelines for planning an acoustic soil and waste system are also discussed during regional seminars for the installation and planning and design industry as well as during conferences. It is possible to organize meetings and dedicated trainings at project specification offices and contractors.

Please send your inquiry to tso@nicoll.pl if you would like to take part in:

- dedicated seminars, trainings, and meetings,
- training on the use of Acad libraries,
- training in designing the dBlue system in the light of the applicable acoustic standards,
- training in the use of acoustic systems in high-rise buildings (Akavent ventilation fitting).

Acoustic dBlue soil and waste System



PRODUCTION



RESEARCH
AND TESTS



INSTALLATION
AND DELIVERY

dBlue SYSTEM
- INSTALLATION

CUTTING PIPES AND MAKING CONNECTIONS

dBlue pipes and fittings have factory made sockets and chamfered spigot ends. Pipes are available in several standard pipe lengths. Fittings are not designed to be shortened. dBlue pipes are made with sockets that are not part of the true pipe length. Ensure measurements are made from the end of the socket, which will prevent pipes becoming too short.



Photo 27



Photo 28

Cut the pipe square using a pipe cutter (Photo 27) or a fine toothed hand saw (Photo 28) for the best results. Fix the pipe before cutting. A mitre box can be used to assist in obtaining a square angle /90°/.

Proper deburring and chamfering of the pipe (Photo 29 and 30) is required to allow the pipe to be inserted past the rubber ring in the socket. The chamfer angle is always 15°. We recommend the use of a purpose designed chamfering tool for best results. Remove any leftover burs using a standard deburring tool.

Table 16 specifies chamfering lengths and angle.

Ø	40	50	75	90	110	125	160	200	[mm]
b	3,0	3,5	3,5	4,5	4,5	5,0	6,0	6,0	[mm]

Table 16



Photo 29

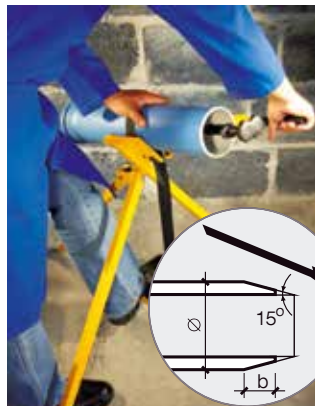

Photo 30

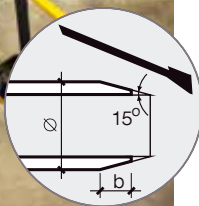

Fig. 33



Photo 31



Photo 32



Photo 33



Photo 34

Take care when chamfering at low temperatures. dBlue can be installed at temperatures as low as -10 °C without becoming brittle.

When making joints the socket of the pipe or fitting added should be in downstream direction for best flow results. Clean the spigot and the socket, including rubber ring, from any dust and dirt. Always apply plenty of dBlue lubricant at the spigot end and the rubber ring. Each joint must initially be made by fully inserting the spigot end into the entire depth of the socket until it stops (Photo 31).

Clearly mark the spigot end at the inserted depth with a permanent pencil or pen. Mark the fitting on a clearly visible side. This will allow visual inspection of each joint after installation (Photo 32).

Pipe that is 500 mm or longer has to be pulled back 10 mm to allow for thermal expansion. Shorter pipes and fittings can remain fully inserted in the socket (Photo 33). Pulling back the spigot end 10 mm from the socket creates enough room to allow for 3 m pipe to expand and contract.

A section or connection made in such a way should be mounted on a wall in previously installed brackets (Photo 34).

NOTE!
Prior to making socket connections make sure the spigot end of a pipe and the rubber ring are lubricated .

Table 17



dBlue ACOUSTIC SOIL & WASTE SYSTEM

dBlue SYSTEM – INSTALLATION

Map out the dBlue stack line using a level (Photo 35). Similarly map out the route of connections keeping in mind the designed slopes.

Measure the installation points for brackets and for connections to sanitary appliances (Photo 36).



Photo 35



Photo 36



Photo 37

Next drill holes (Photo 37) of diameters dependent on the type of brackets. With the wall plug fixed in the wall proceed with fixing a bracket through rotation (Photo 38 and 39).



Photo 38



Photo 39



Photo 40



Photo 41

Insert a pipe or a fitting into the bracket and tighten the two parts of the open bracket with a screw gun (Photo 42).



Photo 42



Photo 43



Photo 44

AKAVENT AERATOR FITTING - INSTALLATION

AKAVENT AERATOR FITTING - INSTALLATION



Photo 45

The Akavent aerator fitting as a ventilation stack.

The expansion socket at the top of the Akavent has a factory made anchor point construction where a dBlue acoustic anchor point bracket can be placed. The pipe socket at the bottom of the Akavent must also contain an anchor point bracket as per the vertical bracketing plan.

DOUBLE BRACKET – INSTALLATION



Photo 46)

dBlue bracket support bracket (lower)

The installed support bracket has no direct contact with the stack. Spacers can be seen in the closed bracket (Photo 46).



Photo 47

dBlue bracket anchor point bracket (upper)

The upper bracket is fixed to the stack transferring the load to the support bracket (Photo 47).

ACOUSTIC FITTINGS



Photo 48

The use of the acoustic elbow and the acoustic collar

The photo illustrates the acoustic elbow installed at a point of change of waste flow from vertical to horizontal and complemented with the vibrations-dampening acoustic collar (Photo 48).

RAINWATER VERTICAL STACK - INSTALLATION



Photo 49

The photo illustrates the bracketing plan for acoustic dBlue brackets on a rainwater vertical stack prepared for an installation of an additional socket tightening clamp (Photo 49).



Photo 50

Tightening clamp

The photo illustrates the rainwater tightening clamp prior to installation (Photo 50).



Photo 51

Tightening clamp installed

The photo illustrates an installed lower part of the tightening clamp on a socket along with the upper part components (Photo 51).



Photo 52

Tightening clamp installed on a rainwater vertical stack

The photo illustrates a fixed tightening clamp on a socket connection of the acoustic dBlue rainwater vertical stack (Photo 52).

PRODUCT RANGE



dBlue - Pipe							
	d_n [mm]	e_n [mm]	L [mm]	dBlue code	Section	Pack	Pack Type
	40	1,8	150	PPA-040-018-015-D		30	DB5
	40	1,8	250	PPA-040-018-025-D		20	DB5
	40	1,8	315	PPA-040-018-031-D		38	DB4
	40	1,8	500	PPA-040-018-050-D		50	DB3
	40	1,8	1000	PPA-040-018-100-D		10	PLT
	40	1,8	1500	PPA-040-018-150-D		10	PLT
	40	1,8	2000	PPA-040-018-200-D		10	PLT
	40	1,8	3000	PPA-040-018-300-D		10	PLT
	50	1,8	150	PPA-050-018-015-D		20	DB5
	50	1,8	250	PPA-050-018-025-D		30	DB4
	50	1,8	315	PPA-050-018-031-D		25	DB4
	50	1,8	500	PPA-050-018-050-D		35	DB3
	50	1,8	1000	PPA-050-018-100-D		10	PLT
	50	1,8	1500	PPA-050-018-150-D		10	PLT
	50	1,8	2000	PPA-050-018-200-D		10	PLT
	50	1,8	3000	PPA-050-018-300-D		10	PLT
	75	2,3	150	PPA-075-023-015-D		20	DB4
	75	2,3	250	PPA-075-023-025-D		25	DB3
	75	2,3	315	PPA-075-023-031-D		24	DB3
	75	2,3	500	PPA-075-023-050-D		15	DB3
	75	2,3	1000	PPA-075-023-100-D		10	PLT
	75	2,3	1500	PPA-075-023-150-D		10	PLT
	75	2,3	2000	PPA-075-023-200-D		10	PLT
	75	2,3	3000	PPA-075-023-300-D		10	PLT
	90	2,8	150	PPA-090-028-015-D		12	DB4
	90	2,8	250	PPA-090-028-025-D		18	DB3
	90	2,8	315	PPA-090-028-031-D		10	DB4
	90	2,8	500	PPA-090-028-050-D		12	DB3
	90	2,8	1000	PPA-090-028-100-D		10	PLT
	90	2,8	1500	PPA-090-028-150-D		10	PLT
	90	2,8	2000	PPA-090-028-200-D		10	PLT
	90	2,8	3000	PPA-090-028-300-D		10	PLT
	110	3,4	150	PPA-110-034-015-D		15	DB3
110	3,4	250	PPA-110-034-025-D	10	DB3		
110	3,4	315	PPA-110-034-031-D	10	DB3		
110	3,4	500	PPA-110-034-050-D	6	DB3		
110	3,4	1000	PPA-110-034-100-D	10	PLT		
110	3,4	1500	PPA-110-034-150-D	10	PLT		
110	3,4	2000	PPA-110-034-200-D	10	PLT		
110	3,4	3000	PPA-110-034-300-D	10	PLT		
125	3,9	150	PPA-125-039-015-D	10	DB3		
125	3,9	250	PPA-125-039-025-D	10	DB3		
125	3,9	315	PPA-125-039-031-D	8	DB3		
125	3,9	500	PPA-125-039-050-D	6	DB3		
125	3,9	1000	PPA-125-039-100-D	45	PLT		
125	3,9	1500	PPA-125-039-150-D	45	PLT		
125	3,9	2000	PPA-125-039-200-D	45	PLT		
125	3,9	3000	PPA-125-039-300-D	45	PLT		
160	4,9	150	PPA-160-049-015-D	6	DB3		
160	4,9	250	PPA-160-049-025-D	4	DB3		
160	4,9	315	PPA-160-049-031-D	4	DB3		
160	4,9	500	PPA-160-049-050-D	28	DB3		
160	4,9	1000	PPA-160-049-100-D	28	PLT		
160	4,9	1500	PPA-160-049-150-D	28	PLT		
160	4,9	2000	PPA-160-049-200-D	28	PLT		
160	4,9	3000	PPA-160-043-300-D	28	PLT		
200	6,2	3000	PPA-200-062-300-A*	10	PLT		

Table 18

* No socket

PRODUCT RANGE

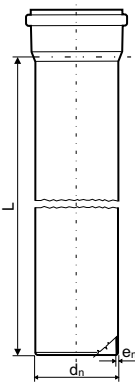
dBlue - Branch									
	α°	d_n [mm]	Z_1 [mm]	Z_2 [mm]	Z_3 [mm]	dBlue code	Section	Pack	Pack Type
	45°	40/40	15	54	54	VTR-040-040-45D		20	DB5
		50/40	13	61	58	VTR-050-040-45D		20	DB4
		50/50	17	67	67	VTR-050-050-45D		20	DB4
		75/40	3	78	71	VTR-075-040-45D		10	DB4
		75/50	1	83	81	VTR-075-050-45D		10	DB4
		75/75	23	96	97	VTR-075-075-45D		10	DB4
		90/40	12	88	83	VTR-090-040-45D		15	DB3
		90/50	2	94	89	VTR-090-050-45D		15	DB3
		90/75	16	106	106	VTR-090-075-45D		15	DB3
		90/90	24	116	116	VTR-090-090-45D		15	DB3
		110/40	19	100	90	VTR-110-040-45D		6	DB4
		110/50	13	108	100	VTR-110-050-45D		6	DB4
		110/75	4	120	118	VTR-110-075-45D		8	DB3
		110/90	12	129	128	VTR-110-090-45D		8	DB3
		110/110	29	140	140	VTR-110-110-45D		7	DB3
		125/110	23	162	162	VTRZ-125-110-045		6	DB3
		125/125	30	162	162	VTR-125-125-45D		5	DB3
		160/110	5	184	190	VTR-160-110-45D		3	DB3
		160/160	45	208	208	VTR-160-160-45D		2	DB3
		200/200	46	244	244	VTR-200-200-45D		1	DB3
67,5°	40/40	15	36	36	VTR-040-040-67D	20	DB5		
	50/40	13	44	41	VTR-050-040-67D	20	DB4		
	50/50	17	45	45	VTR-050-050-67D	20	DB4		
	75/40	8	58	48	VTR-075-040-67D	10	DB4		
	75/50	38	60	53	VTR-075-050-67D	10	DB4		
	75/75	38	65	65	VTR-075-075-67D	10	DB4		
	90/40	7	65	53	VTR-090-040-67D	15	DB3		
	90/50	10	68	59	VTR-090-050-67D	15	DB3		
	90/90	37	78	78	VTR-090-090-67D	15	DB3		
	110/50	12	77	63	VTR-110-050-67D	8	DB4		
	110/75	20	87	80	VTRZ-110-075-067	8	DB3		
110/110	45	94	94	VTR-110-110-67D	8	DB3			
87,5°	40/40	30	29	29	VTR-040-040-90D	20	DB5		
	50/40	29	34	29	VTR-050-040-90D	20	DB4		
	50/50	33	34	35	VTR-050-050-90D	20	DB4		
	75/40	26	47	32	VTR-075-040-90D	10	DB4		
	75/50	32	47	36	VTR-075-050-90D	10	DB4		
	75/75	47	50	50	VTR-075-075-90D	10	DB4		
	90/50	27	55	40	VTR-090-050-90D	15	DB3		
	90/75	40	58	53	VTRZ-090-075-090	15	DB3		
	90/90	53	58	58	VTR-090-090-90D	15	DB3		
	110/40	27	63	36	VTR-110-040-90D	6	DB4		
	110/50	31	65	42	VTR-110-050-90D	6	DB4		
	110/75	44	66	55	VTR-110-075-90D	8	DB3		
	110/90	50	69	63	VTR-110-090-90D	8	DB3		
	110/110	62	70	70	VTR-110-110-90D	7	DB3		
	125/110	60	80	75	VTRZ-125-110-090	6	DB3		
	125/125	74	80	80	VTR-125-125-90D	6	DB3		
	160/110	55	100	85	VTRZ-160-110-090	4	DB3		
	160/160	108	101	101	VTR-160-160-90D	3	DB3		
200/200	107	116	116	VTR-200-200-90D	1	DB3			

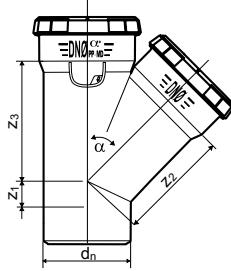
PRODUCT RANGE

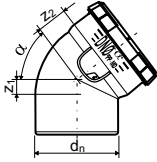
dBlue - Elbow								
	α°	d_n [mm]	Z_1 [mm]	Z_2 [mm]	dBlue code	Cross-section	Pack	Pack Type
	15°	40	4	12	VKL-040-000-15D		20	DB7
		50	4	13	VKL-050-000-15D		20	DB5
		75	12	16	VKL-075-000-15D		20	DB4
		90	15	15	VKL-090-000-15D		15	DB4
		110	14	18	VKL-110-000-15D		8	DB4
	30°	40	7	10	VKL-040-000-30D		20	DB7
		50	8	12	VKL-050-000-30D		20	DB5
		75	14	15	VKL-075-000-30D		20	DB4
		90	20	19	VKL-090-000-30D		15	DB4
		110	20	22	VKL-110-000-30D		8	DB4
	45°	40	12	18	VKL-040-000-45D		20	DB7
		50	12	20	VKL-050-000-45D		20	DB5
		75	20	28	VKL-075-000-45D		20	DB4
		90	26	32	VKL-090-000-45D		10	DB4
		110	25	35	VKL-110-000-45D		14	DB3
		125	35	45	VKL-125-000-45D		14	DB3
		160	38	60	VKL-160-000-45D		6	DB3
	200	46	64	VKL-200-000-45D	2		DB3	
	67,5°	40	16	20	VKL-040-000-67D		20	DB7
		50	26	23	VKL-050-000-67D		20	DB5
		75	30	31	VKL-075-000-67D		20	DB4
		90	39	40	VKL-090-000-67D		10	DB4
		110	45	44	VKL-110-000-67D		14	DB3
	87,5°	40	29	30	VKL-040-000-90D		20	DB7
		50	33	35	VKL-050-000-90D		20	DB5
		75	41	49	VKL-075-000-90D		20	DB4
		90	54	59	VKL-090-000-90D		10	DB4
		110	61	75	VKL-110-000-90D		14	DB3
		125	75	78	VKL-125-000-90D		10	DB3
		160	99	98	VKL-160-000-90D		4	DB3
	200	105	122	VKL-200-000-90D	2		DB3	

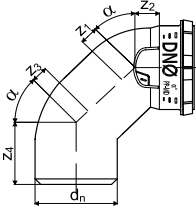
dBlue - Stabilising Elbow											
	α°	d_n [mm]	Z_1 [mm]	Z_2 [mm]	Z_3 [mm]	Z_4 [mm]	dBlue code	Cross-section	Pack	Pack Type	
	90°	50	11	18	10	40	VKL-050-LBR-090D		5	DB5	
		75	19	26	18	63	VKL-075-LBR-090D		5	DB5	
		110	24	33	23	87	VKL-110-LBR-090D		5	DB4	

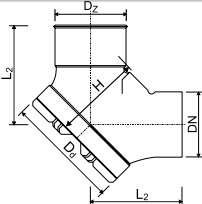
dBlue - Acoustic (Inspection) Elbow										
	α°	d_n [mm]	L_1 [mm]	L_2 [mm]	H [mm]	dBlue code	Cross-section	Pack	Pack Type	
	90°	110	156	129	234	VKL-110-AKU-90D		1	FOL	

PRODUCT RANGE

dBlue - Acoustic - Dampening Collar

NEW!

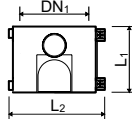
	DN ₁ [mm]	L ₁ [mm]	L ₂ [mm]	dBlue code	Cross-section	Pack	Pack Type
							
	105	105	105	VKO-110-AKU-00D		1	FOL

dBlue - Sleeve socket

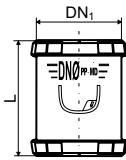
	DN ₁ [mm]	L [mm]	dBlue code	Cross-section	Pack	Pack Type	
	40	95	VMP-040-000-00D		20	DB7	
	50	100	VMP-050-000-00D		20	DB5	
	75	104	VMP-075-000-00D		20	DB4	
	90	111	VMP-090-000-00D		15	DB4	
	110	116	VMP-110-000-00D		6	DB5	
	125	120	VMP-125-000-00D		8	DB4	
	160	140	VMP-160-000-00D		6	DB3	
	200	217	VMP-200-000-00D		4	DB3	

dBlue - Double socket

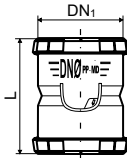
	DN ₁ [mm]	L [mm]	dBlue code	Cross-section	Pack	Pack Type	
	40	95	VMD-040-000-00D		20	DB7	
	50	97	VMD-050-000-00D		20	DB5	
	75	104	VMD-075-000-00D		20	DB4	
	90	111	VMD-090-000-00D		15	DB4	
	110	116	VMD-110-000-00D		6	DB5	
	125	120	VMD-125-000-00D		8	DB4	
	160	140	VMD-160-000-00D		6	DB3	
	200	217	VMD-200-000-00D		4	DB3	

PRODUCT RANGE

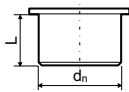
dBlue - Socket plug						
	d_n [mm]	L [mm]	dBlue code	Cross-section	Pack	Pack Type
	40	32	VKK-040-000-00D		20	DB7
	50	32	VKK-050-000-00D		20	DB7
	75	33	VKK-075-000-00D		20	DB7
	90	36	VKK-090-000-00D		20	DB5
	110	37	VKK-110-000-00D		20	DB4
	125	38	VKK-125-000-00D		20	DB4
	160	40	VKK-160-000-00D		34	DB3
	200	59	VKK-200-000-00D		20	DB3

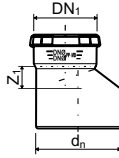
dBlue - Asymmetric reducer						
	d_r/DN_1 [mm]	Z_1 [mm]	dBlue code	Cross-section	Pack	Pack Type
	50/40	25	VRD-050-040-00D		15	DB7
	75/40	25	VRD-075-040-00D		20	DB5
	75/50	25	VRD-075-050-00D		20	DB5
	90/40	40	VRD-090-040-00D		30	DB4
	90/50	35	VRD-090-050-00D		30	DB4
	90/75	24	VRD-090-075-00D		15	DB4
	110/50	25	VRD-110-050-00D		17	DB4
	110/75	25	VRD-110-075-00D		15	DB4
	110/90	30	VRD-110-090-00D		6	DB5
	125/110	30	VRD-125-110-00D		10	DB4
	160/110	35	VRD-160-110-00D		15	DB3
	160/125	35	VRD-160-125-00D		10	DB3
	200/160	34	VRD-200-160-00D		8	DB3

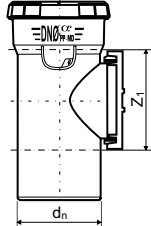
dBlue - Inspection Pipe						
	d_n [mm]	Z_1 [mm]	dBlue code	Cross-section	Pack	Pack Type
	50	69	VCZ-050-000-00D		10	DB5
	75	90	VCZ-075-000-00D		10	DB4
	90	109	VCZ-090-000-00D		6	DB4
	110	131	VCZ-110-000-00D		6	DB4
	125	154	VCZ-125-000-00D		8	DB3
	160	209	VCZ-160-000-00D		3	DB3
	200	228	VCZ-200-000-90AD*		3	DB3

* item made to order

PRODUCT RANGE

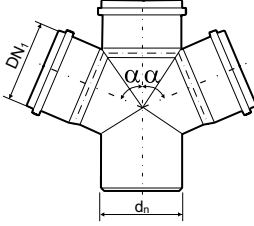
dBlue - double branch							
	α°	d_n [mm]	DN_1 [mm]	dBlue code	Cross-section	Pack	Pack Type
	67,5°	50	50	VCRZ-050-050-067			
		90	90	VCRZ-090-090-067		20	DB3
		110	50	VCRZ-110-050-067		5	DB3
		110	110	VCRZ-110-110-067		4	DB3
	87,5°	50	50	VCRZ-050-050-090			
		90	90	VCRZ-090-090-090		20	DB3
		110	50	VCRZ-110-050-090		5	DB3
		110	110	VCRZ-110-110-090		4	DB3
		160	110	VCRZ-110-160-090			

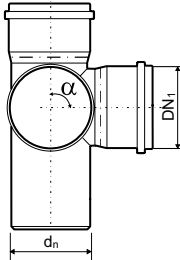
dBlue - double-corner branch							
	α°	d_n [mm]	DN_1 [mm]	dBlue code	Cross-section	Pack	Pack Type
	67,5°	110	110	VCNZ-110-110-067		5	DB3
	87,5°	110	110	VCNZ-110-110-090		5	DB3

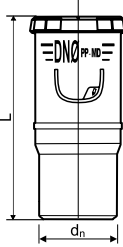
dBlue - expansion socket							
	d_n [mm]	L [mm]	dBlue code	Cross-section	Pack	Pack Type	
	75	179	VDK-075-000-00D		18	DB4	
	90	193	VDK-090-000-00D		10	DB4	
	110	201	VDK-110-000-00D		6	DB4	

PRODUCT RANGE

NEW!

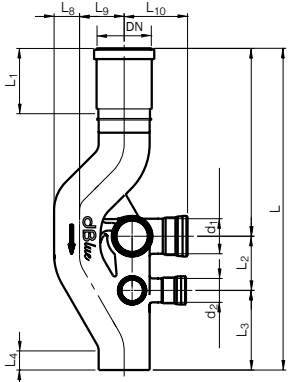
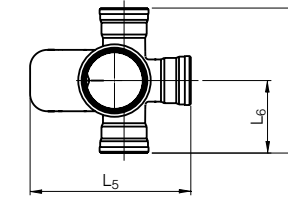
dBlue – Akavent Aerator *																
	DN [mm]	d ₁ [mm]	d ₂ [mm]	dBlue code	Cross-section										Pack	Pack Type
	110	110	75	VVEN-110-110-75D											1	-
	160	110	75	VVEN-160-110-75D											1	-
DN [mm]	d ₁	d ₂	L [mm]	L ₁	L ₂	L ₃	L ₄	L ₅	L ₆		L ₇	L ₈	L ₉	L ₁₀		
110	110	75	956	256	170	240	60	344	159		313	55	130	159		
160	110	75	1010	256	170	250	60	404	179		358	80	140	184		

*special configuration (side inlets) item made to order

NEW!

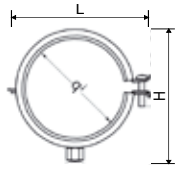
dBlue - bracket							
	Ø [mm]	L [mm]	H [mm]	dBlue code	Cross-section	Pack	Pack Type
	40	98	78	POB-STL-040-000		20	KARTON
	50	125	102	POB-STL-050-000		20	KARTON
	75	141	116	POB-STL-075-000		20	KARTON
	90	159	145	POB-STL-090-000		20	KARTON
	110	176	158	POB-STL-110-000		10	KARTON
	125	215	194	POB-STL-125-000		10	KARTON
	160	248	239	POB-STL-160-000		10	KARTON
	200	281	269	POB-STL-200-000		10	KARTON

NEW!

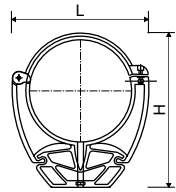
dBlue - Phonoklip bracket							
	Ø [mm]	L [mm]	H [mm]	dBlue code	Cross-section	Pack	Pack Type
	40	67	72	POB-PHO-040-000		20	DB5
	50	78	84	POB-PHO-050-000		20	DB5
	75	111	138	POB-PHO-075-000		20	DB5
	90	131	127	POB-PHO-090-000		20	DB5
	110	149	168	POB-PHO-110-000		10	DB4
	125	170	191	POB-PHO-125-000		10	DB4
	160	213	232	POB-PHO-160-000		10	DB4
	200	268	303	POB-PHO-200-000		10	DB4

PRODUCT RANGE

dBlue - reinforcing flanges

NEW!



DN [mm]	DN ₁ [mm]	DN ₂ [mm]	H [mm]	L ₁ [mm]	L ₂ [mm]	dBlue code	Cross-section	Pack	Pack Type
110	110	116	67	142	150	VDSC-KIE-STL-110		1	FOL
160	160	170	77	190	190	VDSC-KIE-STL-160		1	FOL

dBlue - metal clip

NEW!



DN [mm]	DN ₁ [mm]	L ₁ [mm]	H [mm]	dBlue code	Cross-section	Pack	Pack Type
110	110	150	40	VCLP-KIE-STL-110		1	FOL
160	170	190	50	VCLP-KIE-STL-160		1	FOL
200	213	245	60	VCLP-KIE-STL-200		1	FOL

fire-protection collar PACIFYRE



Ø [mm]	dBlue code	Cross-section	Pack	
40	POG-040-000-000*		1	
50	POG-050-000-000*		1	
75	POG-075-000-000*		1	
90	POG-090-000-000*		1	
110	POG-110-000-000*		1	
125	POG-125-000-000*		1	
160	POG-160-000-000*		1	
200	POG-200-000-000**		1	

* item made to order
** AWM III Type

PRODUCT RANGE

Roof outlet – gravitational with a vertical outlet									
	dn [mm]	dBlue code	Cross-section	A [mm]	B [mm]	C [mm]	D [mm]	E [mm]	
NEW!		110	DR 410		110	135	380	320	110
		110	DR 410F *		110	135	380	320	110
		160	DR 610		85	160	380	320	160
		160	DR 610F *		85	160	380	320	160

* flat grid roof outlet identification

Roof outlet – gravitational with a horizontal outlet									
	dn [mm]	dBlue code	Cross-section	A [mm]	B [mm]	C [mm]	D [mm]	E [mm]	
NEW!		110	DR 430		165	380	320	285	110
		110	DR 430F *		165	380	320	285	110

* flat grid roof outlet identification



For a specific configuration of specialist fittings or items made to order please contact our Technical Support Team at tso@nicoll.pl

Table 19

TECHNICAL SHEET
- dBlue ACOUSTIC SOIL & WASTE SYSTEM

Applications	- Sanitary soil & waste system - Rain drainage gravitational system
Type of Buildings [height] [Polish Building Regulations] [m]	- Low H ≤ 12m - Medium H - 12 ÷ 25m - High H - 25 ÷ 55m - High-rise H > 55m
Type of Buildings [function]	- Hotels - Apartments - Office buildings - Security and Health Service - Administration - Education - Sport - Cultural
Acoustic performance [Fraunhofer test report] [dB]	Brackets - dBlue bracket: Measured noise :14 dB (0,5l/s); 16 dB (1 l/s); 16 dB (2 l/s); 18 dB (4 l/s) Phonoklip brackets: Measured noise: ≤ 10dB (0,5l/s); ≤ 10 dB (1 l/s); 10 dB (2 l/s); 16 dB (4 l/s)
Acoustic performance (air-borne noise) [dB]	Reduction by a value: - 6,6 dB (2,0l/s) - 5,9 dB (4,0l/s)
Material formula	Polypropylene PP and Modified polypropylene PP - MD
Colour of Pipes (layers)	Internal: light grey RAL 7040; Intermediate: cream or dark grey External: blue RAL 5012
Colour of Fittings	Blue one-layer wall RAL 5012
Density [g/cm ³]	1.2 g/cm ³ - external layer; 1.4 g/cm ³ - internal layer
Ring stiffness [KN/m ²]	SN ≥ 4 KN/m ²
Co-efficient [thermal expansion] [mm/mk]	0,1 mm/mK
Diameters of pipes and fittings [mm]	d _n - 40, 50, 75, 90, 110, 125, 160, 200 mm
Wall thickness [mm]	(d _n 40 - 50mm) e=1.8mm (d _n 75 mm) e=2.3mm (d _n 90 mm) e=2.8mm (d _n 110mm) e=3.4mm (d _n 125mm) e=3.9mm (d _n 160mm)e=4.9mm (d _n 200mm) e=6.2mm
Connection type	Socket with a gasket + 'plain' end - push-fit
Special fittings	- Aerator (ventilation fitting) (Akavent) - Acoustic-inspection elbow - Acoustic sleeve - Welded fittings - Roof outlets [rain drainage] (Alutec) - Reinforcing flanges
Type of clamps	18 dB - dBlue bracket (metal) - DN 40, 50, 75, 90, 110, 125, 160, 200 16 dB - Phonoklip - DN 40, 50, 75, 90, 110, 125, 160, 200
Fire resistance class	E (EN 13501); B2 (DIN 4102)
Maximum Temperature of Waste [°C]	+ 90 °C - Continuous + 95 °C - Temporary
Minimum Installation Temperature [°C]	Below (-10°C)

Table 20

Note: The above technical and acoustic performance data of the dBlue system have been developed and drafted by independent international testing bodies.

dBlue ACOUSTIC SOIL & WASTE SYSTEM

dBlue SYSTEM MARKING

The dBlue system marking includes the following data for full identification:

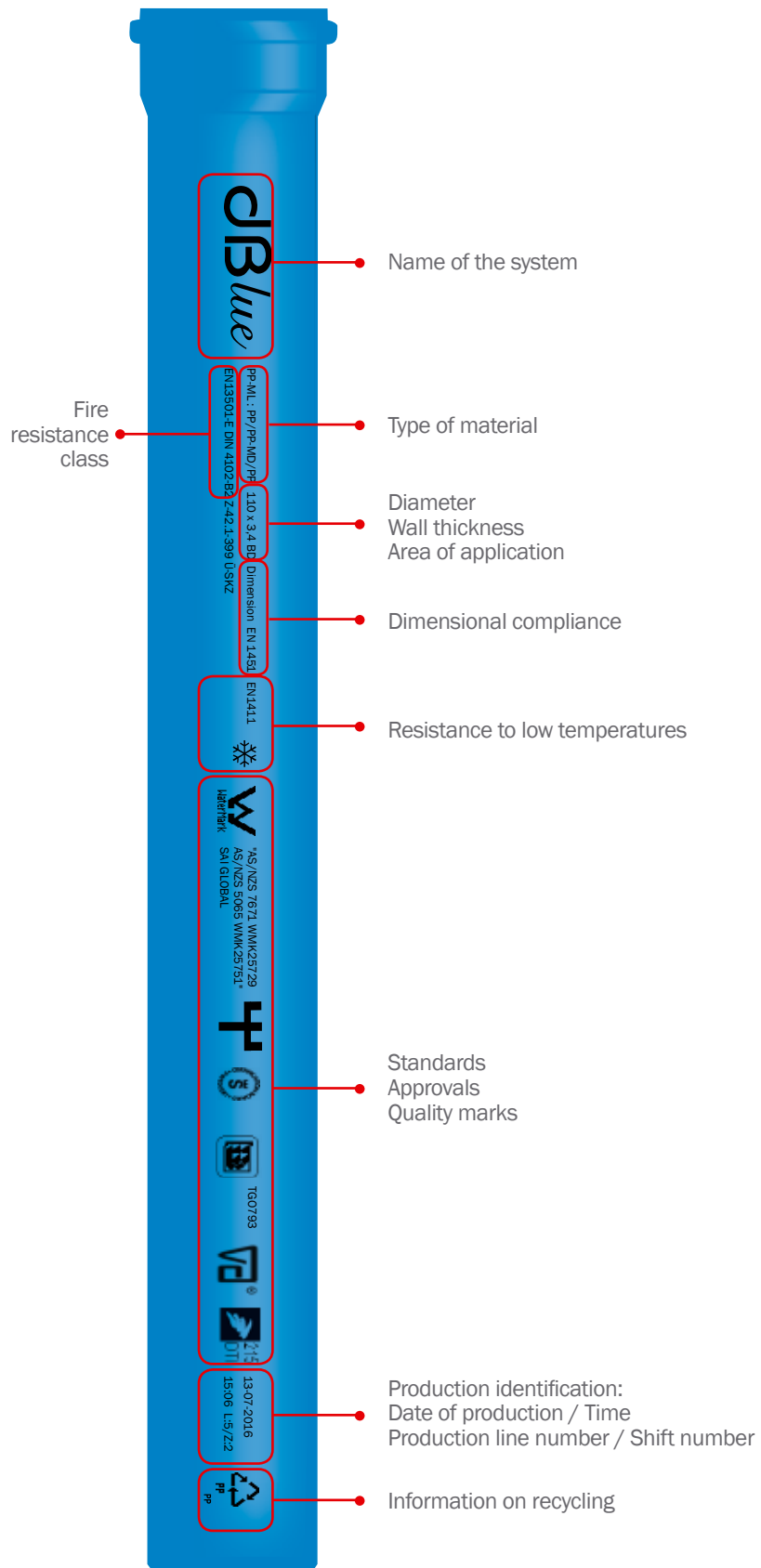

Fig. 34



The above-presented identification ensures full control of the high quality of the dBlue system, its storage, logistics and trade distribution.

Table 21

**PACKING PIPES, FITTINGS AND BRACKETS
– TYPES OF PACKAGING**

In order to simplify identification of particular components of dBlue system, 3 types of cardboard box packaging and one type of pallet packaging are offered.

1) Type 1 packaging – dBlue pipes and fittings

- designed for all fittings and pipes of length up to 0.5 m (L = 0.15; 0.25; 0.31; 0.5 m),
- colour: blue and white,
- cardboard boxes in four sizes: DB 3, DB 4, DB 5, DB 7.



Fig. 35

2) Type 2 packaging – Phonoklip brackets (16 dB)

- designed for Phonoklip brackets across the range DN 40, 50, 75, 90, 110, 125, 160, 200,
- colour: black and white,
- cardboard boxes in four sizes: DB 4, DB 5.



Fig. 36

3) Type 3 packaging – dBlue brackets (steel)

- designed for dBlue brackets across the range DN 40, 50, 75, 90, 110, 125, 160, 200,
- colour: blue and white,
- cardboard boxes in four sizes: DB 4, DB 5.



Fig. 37

4) Pallet

- designed for packing pipes* over 0.5 m in length (L = 1.0; 1.5; 2.0; 3.0 m),
- *Pallet packaging is also used as collective packaging.



Photo 53

Depending on the planned acoustic standard of the investment particular components (pipes, fittings, clamps) of the dBlue system will be delivered in two options:

Option 1

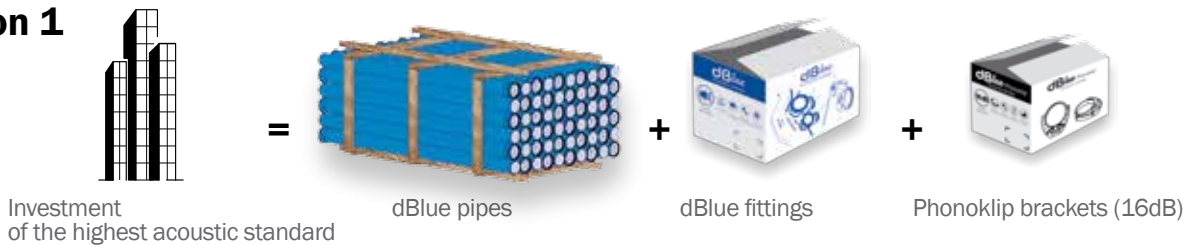

Option 2

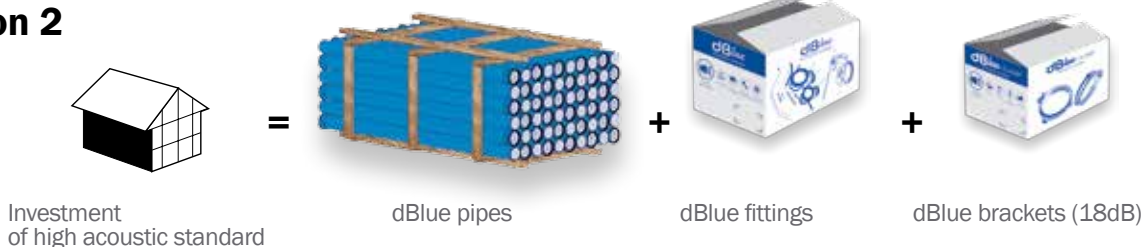

PACKING, STORAGE, AND TRANSPORTING dBlue SYSTEM PIPES AND FITTINGS

DIMENSIONS OF CARD-BOARD BOXES

The cardboard box system is based on four types of standardized cardboards: DB 3; DB 4; DB 5; and DB 7. The following figure presents complete dimensions for each of them:

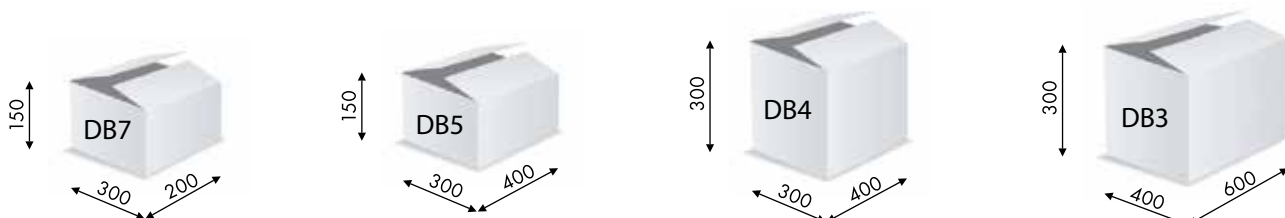

Fig. 38

STORAGE AND TRANSPORT

dBlue pipes and fittings must not be transported loose with other building materials that may damage them. Pipes should be transported in horizontal position. During unloading in temperatures below zero degrees pipes should be secured against damaging. Do not throw, pull, or bend the pipes nor fittings while unloading at storage yards or construction sites. Collective packing is fully prepared for pneumatic jack and forklift trucks. Sections of pipes should be stored on a flat and clean area horizontally, up to 1.5 m

high. All products should be secured against sunlight. It is allowed to store them outdoors for no longer than 12 months. Pipes and fittings should be stored separately in particular diameters and lengths.

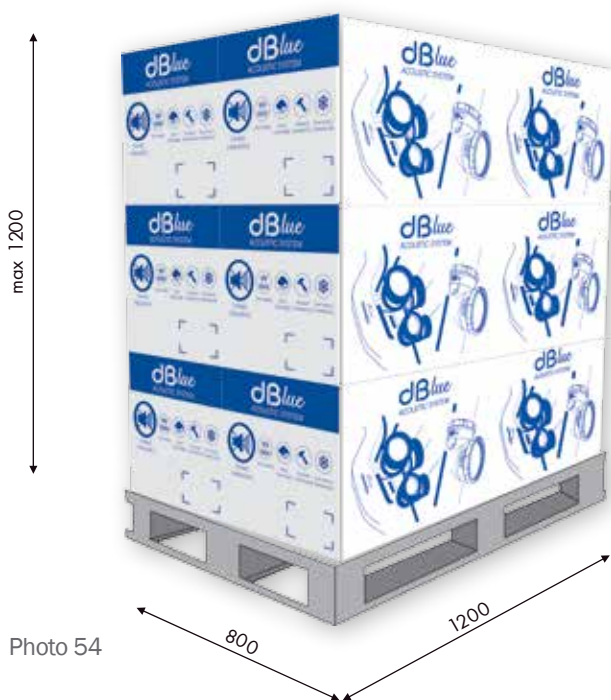

Photo 54



Photo 55

Cardboard boxes are stacked up to maximum 1200 mm in height on a 800 mm x 1200 mm pallet. Fittings must be kept in their original packaging in a dry covered area and must be protected against moisture, dirt, solids and UV radiation.

FIRE PROTECTION FIRE COLLARS / BULKHEADS

FIRE PROTECTION IN BUILDINGS

Fire protection in buildings and in individual rooms is a significant planning aspect thoroughly analysed in all cases. When a fire breaks out it spreads very quickly using every possible way to get to other rooms, especially to rooms located above the room where the fire was initiated. Every unprotected pipe duct is exposed to propagation of fire, gases and burning condensate that may initiate fire on lower floors. An appropriate choice of safe material of which the pipes and fittings are made as well as locating fire collars of appropriate fire resistance class provides a guarantee of obtaining an approval for the fire protection system and safe use of the building.



Photo 56

FIRE CLASSIFICATION OF BUILDING MATERIALS

To date two fire standards have been in force on the European market: DIN 4102 "Reaction to fire tests - Ignitability of building products" and the new European standard PN-EN 13501 "Fire classification of construction products and building elements". PN-EN 13501 standard provides the classification rules for reaction to fire for all building products. The quoted standard, in contrast to DIN 4102, apart from the fire classification, tests other additional parameters.

According to the afore-mentioned EN 13501 standard, the dBlue system has been classified under "E" class products and according to the present standard DIN 4102 under class "B-2". Both standards define materials used for producing the dBlue system as normally flammable/non-toxic (able to resist the effect of flames for a short time without significant effect on the propagation of fire).

FIRE RESISTANCE OF PASSAGES

EN 1366-3:2006 standard sets forth requirements for fire passages in securing passages through walls and construction barriers. Their main task is to efficiently block the propagation of fire and smoke through the pipe duct.

FIRE COLLARS

PACIFYRE FIRE STOP MK II P

It is recommended that fire collars Pacifyre Fire Stop MK II P be used with the dBlue acoustic soil & waste system. These are class E I 120 min fire collars. The fire resistance class (time given in minutes) specifies a time frame during which the construction barrier and the fire passage keep their load-bearing capacity, tightness and fire insulation. It is a minimum time related to initiating a rescue and evacuation operation and the arrival of a fire brigade at a place of fire.

It is worth noticing that in the case of Pacifyre fire collars securing the passage through a wall in the place of two collars or cassettes on both sides of the construction barrier, one Pacifyre collar secures both sides of the construction barrier.



PACIFYRE FIRE STOP MK II P FIRE COLLARS IN ACTION

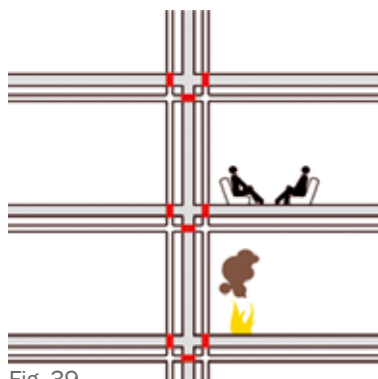

Fig. 39

The figure presents location of fire collars on pipe ducts and the initial moment of fire breaking out in a fire-separated room.

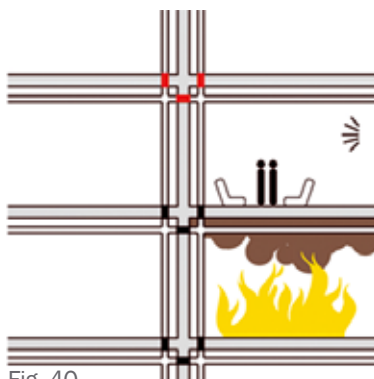

Fig. 40

The fire spreads very fast making already in 140°C the fire collar on a pipeline clamp through the swelling of its lining. At the same time, the alarm system is switched on.



Fig. 41

The collar successfully prevents the fire and smoke from propagating to an adjoining room (120 min.) allowing for a safe evacuation and arrival of the fire brigade.

PACIFYRE FIRE STOP MK II P

The Pacifyre fire collar consists of a stainless steel sleeve (body) and an element operating against pressure. The steel sleeve is finished with three protections on one side and three loops on the other side where the closing tabs are inserted and which clamp the collar on a pipe. The lining on the steel body swells in high temperatures and is responsible for the collar's operation. A layer of intumescent ensures a seal in the event of a fire. The three foam strips prevent the noise and smoke from penetrating another area.

PACIFYRE FIRE COLLARS - INSTALLATION

Examples of installing collars in different set-ups.

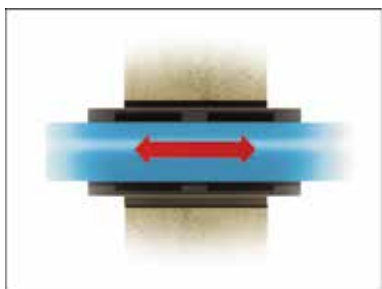

Fig. 42

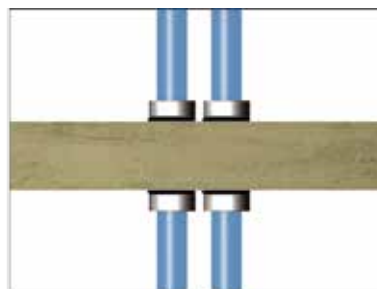

Fig. 44

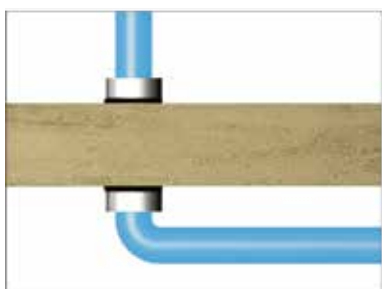

Fig. 43

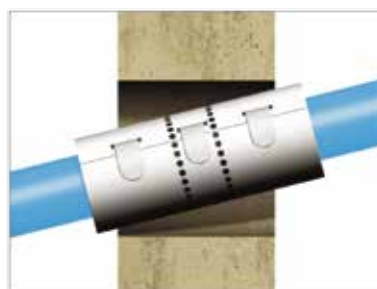

Fig. 45

**INSTEAD OF TWO TRADITIONAL COLLARS ON BOTH SIDES OF THE HOLE
- ONE PACIFYRE**



Photo 57



Photo 58



Photo 59

TABLE OF CHOOSING FIRE COLLARS AND THE MINIMUM DIAMETER OF A HOLE IN A WALL

No.	Article code	Pipe diameter [mm]	Hole diameter [mm]
1	POG-040-000-000;	40	75
2	POG-050-000-000	50	85
3	POG-075-000-000	75	110
4	POG-090-000-000	90	125
5	POG-110-000-000	110	145
6	POG-125-000-000	125	174
7	POG-160-000-000	160	195
8	POG-200-000-000*	200	235

* - Type AWM III

Table 22

APPROVALS, STANDARDS AND QUALITY

APPROVALS, STANDARDS AND QUALITY

1 APPROVALS

dBlue has been approved by the following certification bodies:

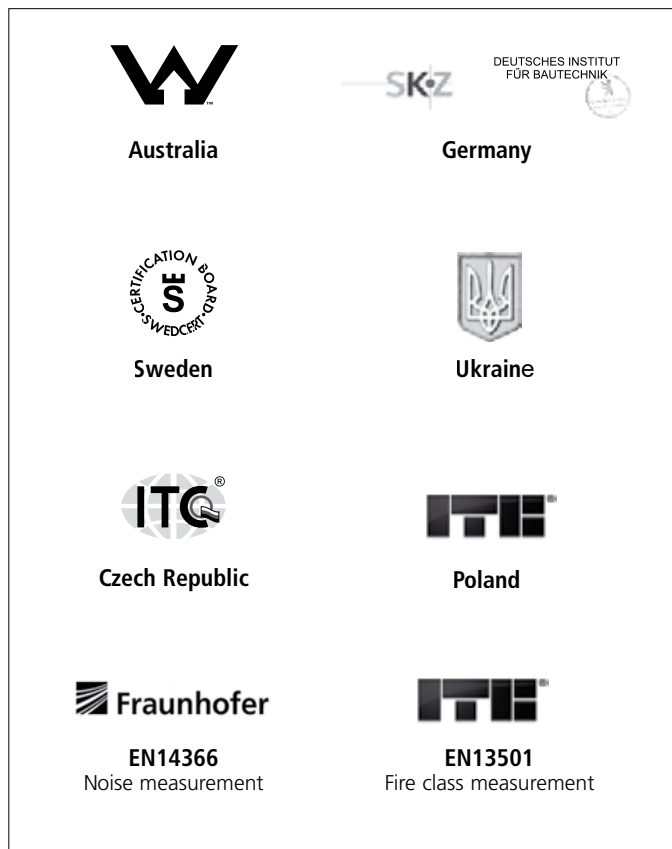

3 QUALITY MANAGEMENT

dBlue is developed and manufactured in compliance with ISO 9001 Quality Assurance system. It emphasises quality assurance and continuous improvements for customer satisfaction. Furthermore Nicoll Polska has integrated the ISO 14001 environmental management system to control and improve its overall environmental performance.

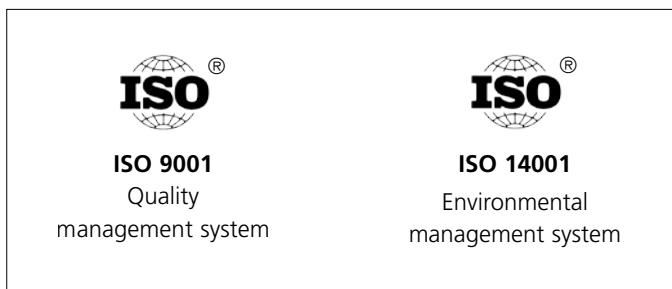

2 STANDARDS

dBlue is a professional acoustic soil & waste system and meets a number of quality and safety standards.

EN 1451

Plastic piping systems for soil and waste discharge (low and high temperature) within the building structure. Polypropylene (PP). Specifications for pipes, fittings and the system.

EN 1411

Plastic piping and ducting systems. Thermoplastic pipes. Determination of resistance to external blows by the staircase method.

EN 14366

Laboratory measurement of noise from waste water installations.

EN 13501

Fire classification of construction products and building elements.

DIN 4102

Fire behaviour of building materials and building components.

EN 1055

Plastic piping systems. Thermoplastic piping systems for soil and waste discharge inside buildings. Test method for resistance to elevated temperature cycling.

EN 1054

Plastic piping systems. Thermoplastic piping systems for soil and waste discharge. Test method for airtightness of joints.

EN 681

Elastomeric seals. Material requirements for pipe joint seals used in water and drainage applications.

4 NICOLL POLSKA AND ALIAXIS

Nicoll Polska is part of Aliaxis, which is the leading producer of plastic pipe systems in the world. The Aliaxis group has over 16.000 employees and comprises of more than 100 companies with subsidiaries in 40 countries.

All companies operate under their own brand and are specialized in specific solutions for building, industrial and utility applications. Nicoll Polska is the brand within Aliaxis focusing on specialist drainage systems in the building sector. Aliaxis has a global network with professional local support offices offering promotional, sales, supply, training and on-site support services.

CHEMICAL RESISTANCE

The current state of knowledge about chemical resistance of plastics is based on long-lasting laboratory tests and practical experience. The following evaluation can be an initial indicator of the possibilities of dBlue application for fluid transportation including transport at elevated temperatures. dBlue pipes and fittings and rubber gaskets are meant for transporting waste water ranging from acids (pH 2) to alkalis (pH 12) present in households. In case of industrial waste water, its chemical composition and concentration should be analyzed. The table covers a set of chemicals and determination of the dBlue chemical resistance.

The following evaluation criteria were adopted:

- z – satisfactory resistance
- o – limited resistance
- n – unsatisfactory resistance

- Concentration:
- rr – diluted solution
- rn – saturated solution
- rnn – unsaturated solution
- rp – industrial solution

	Concentration	Temperature		
		20°C	60°C	95°C
Acetone	100%	z	o	
Ethyl acrylate	100%	n	n	
Benzaldehyde	0,1%	z		
Crotonaldehyde	100%	n	n	
Acetaldehyde	40% 100%	n		
Amyl alcohol		z	z	
Ammonia, non-associated gas	13%	z	z	
Ammonia, pzn	100%	z	z	
Ammonia, aqueous solution	r	z	z	
Ammonium nitrate	rn	z	z	z
Ammonium chloride	rn	z	z	z
Ammonium sulphate	rn	z	z	z
Aniline	100%	z	o	
Aniline	rn	z	o	
Aniline hydrochloride	rn	o	o	
Antimony chloride	90%	z	z	
Benzene	100%	o	n	
Petrol (aliphatic hydrocarbons)		o	n	
Petrol (aliphatic hydrocarbons)	80/20	o	n	
Acetic anhydride	100%	z		
Borax	rn	z	z	
Bromine, liquid	100%	n	n	
Butane, gas	100%	z	z	
Butanols	to 100%	z	z	
Chlorine, non-associated gas	100%	n	n	
Chlorine, aqueous solution	rn	n	n	
Sugar	rn	z	z	o
Cyclohexanol	100%	z	z	
Cyclohexanone	100%	z	n	
Tin chloride	rn	z	z	
Zinc chloride	rn	z	z	z
Dextrine	rn	z		
Dichloromethane	100%	o	n	
Ethanol	95%	z		
Ethyl ether	100%	o		
Ethylene glycol	rp	z	z	
Phenol	90%	z	z	
Copper fluoride	2%	z	z	
Copper sulphate	rn	z	z	
Dairy		z	z	o
Urine		z	z	
Urea	10%	z	z	
Soap	rnn	z	z	
Nickel sulphate	rn	z	z	
Vinegar	to 8%	z	z	
Butyl acetate	100%	z	o	
Ethyl acetate	100%	o	o	
Oils and fats		z		
Ozone	100%	z	o	
Pyridine	do 100%	z	o	z
Beer		z		z
Potassium nitrate	rn	z	z	
Potassium bromide	rn	z	z	z
Potassium chloride	rn	z	z	
Potassium chromate	40%	z	z	
Potassium cyanide	rnn	z	z	
Potassium dichromate	40%	z	z	
Potassium dihydrogen phosphate	rn	z		
Potassium permanganate	20%	z	o	
Potassium hydroxide	rnn	z		
Potassium ferricyanide	rn	z		

	Concentration	Temperature		
		20°C	60°C	95°C
Formaldehyde	rr	z	z	
Formaldehyde	40%	z	z	
Glycerol	100%	z	z	
Hexane	100%	z	o	
Xylene	100%	o	n	
Nitric acid	to 45%	z	z	
Nitric acid	50 to 98%	o	n	
Benzoic acid	rn	z	z	z
Boric acid	rr	z	z	
Chlorosulphuric acid	100%	n	n	
Chlorosulphuric acid (hydrochloric)	20%	z	z	
Chlorosulphuric acid (hydrochloric)	> 30%	z	z	
Chromic acid	1,50%	z	o	
Citric acid	rn	z	z	z
Citric acid	rn	z	z	z
Hydrofluoric acid	40%	z	z	
Hydrofluoric acid	60%	z	z	
Hydrofluoric acid, gas	100%	z	z	
Glycolic acid	30%	z	z	
Lactic acid	10%	z	z	z
Lactic acid	10,90%	z	z	
Formic acid	1,50%	z	z	
Acetic acid	25%	z	z	z
Acetic acid	60%	z	z	
Acetic acid	l	z	o	
Oleic acid	100%	z		
Sulphuric acid	96%	z	o	
Sulphuric acid	40,90%	z	z	
Sulphuric acid, smoking (oleum)	10% SO3	n	z	
Oxalic acid	rn	z	z	z
Oxalic acid	rr	z	z	
Tannic acid	rnn	z	z	
Lartaric acid	to 10%	z	z	
Magnesium chloride	rn	z	z	
Magnesium sulphate	rn	z	z	
Methanol	100%	z	z	
Copper chloride	rn	z	z	
Potassium ferrocyanide	rn	z		
Liquid propane	100%	z		
Sulphur dioxide, liquid	100%	z	z	
Sulphur dioxide, dry	100%	z	z	
Hydrogen sulphide, gas	100%	z	z	
Sodium benzoate	35%	z		
Sodium chlorate	rn	z	z	
Sodium chloride	rn	z	z	z
Sodium hypochlorite (13% chloride)	100%	z	z	
Sodium sulphite	rn	z	z	
Sodium hydrogensulfide	rn	z	z	
Sodium hydroxide	rn	z	z	
Sodium ferricyanide	rn	z		
Sodium ferrocyanide	rn	z		
Silver nitrate	rn	z		
Oxygen	100%	z	z	
Toluene	100%	o	n	
Trichloroethylene (TRI)	100%	o	n	
Calcium nitrate	50%	z	z	
Carbon disulphide	100%	o	n	
Wine		z	z	
Seawater		z	z	z
Hydrogen peroxide	30%	z	o	
Photographic developers	rp	z	z	

Table 23

CONTENTS

Introduction – Innovations in the dBlue acoustic system	- 2
Acoustics in the construction industry – basic terminology	- 6
Background noises, standards and regulations	- 7
Acoustic safety in rooms	- 8
– Permissible noise levels	
Origin and reduction of noise coming from waste water installations	- 9
– Structure-borne noise	
– Air borne noise	
Acoustic characteristics – dBlue system	- 14
New generation of dBlue 16 dB – product concept	- 16
Planning and design guidelines	- 20
Area of application of dBlue system	- 21
Planning, Lay-out and Installation	- 26
Design and technical support	- 30
Installation	- 32
dBlue Product Range	- 35
Product technical sheet	- 44
Marking	- 45
Packing, storage and transporting	- 46
Fire safety	- 48
Approvals, standards and quality	- 51
Chemical resistance	- 52

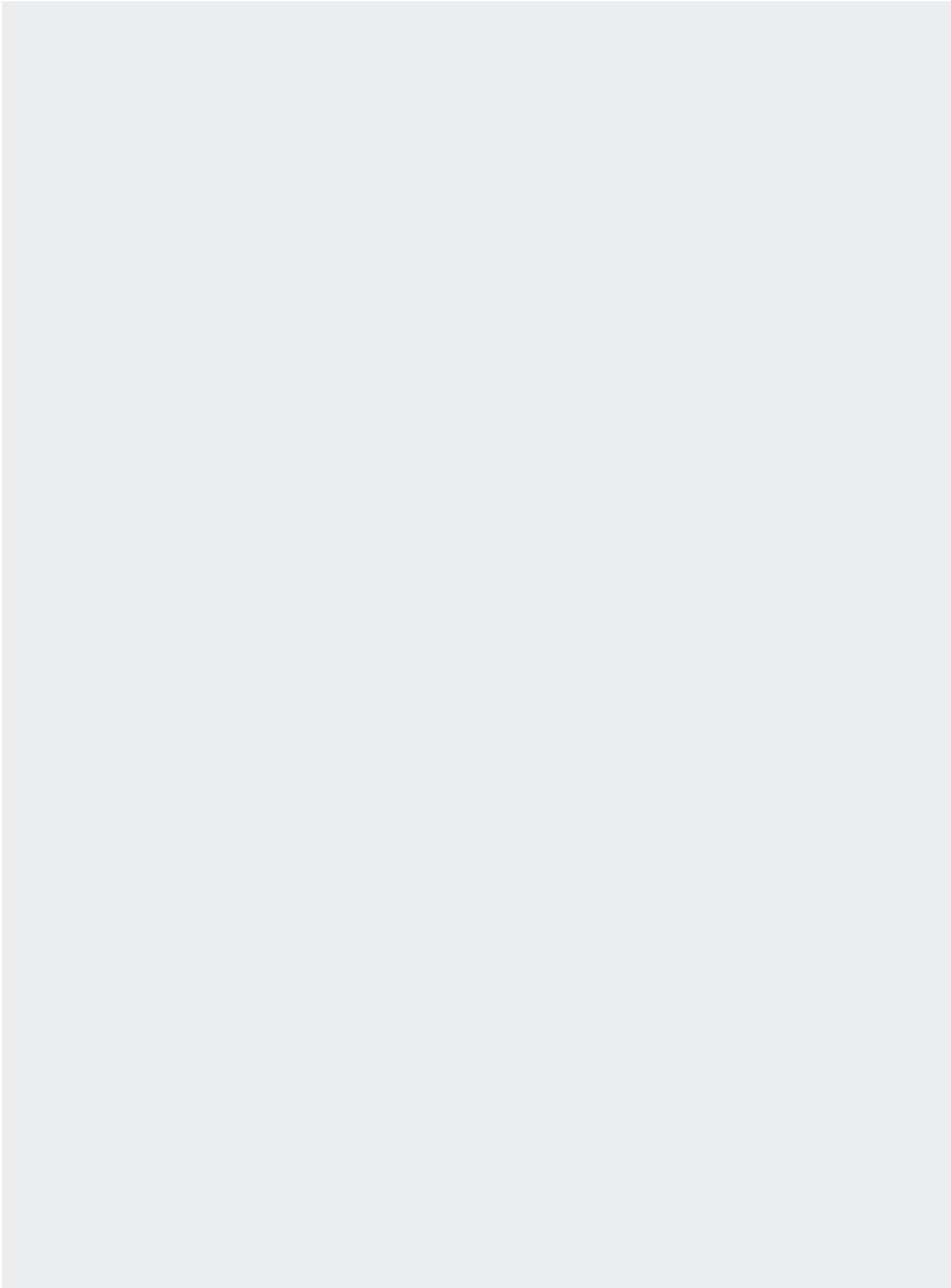



NICOLL POLSKA Sp. z o.o.
Energetyczna Str. 6, 56-400 Olesnica, Poland, Tel. +48 71/399 56 00, Fax +48 71/399 56 01

export@nicoll.pl; www.nicoll.pl

an *Aliaxis* company