

Kvalitetsbeslag til konkurrence-dygtige priser

Line 18° er en omfangsrig serie af bygningsbeslag, der med sit enkle, funktionelle design og gunstige prisniveau passer perfekt til de fleste bygningsformer.

Vi har udvalgt en serie af standardbeslag med bl.a. dørgreb, skilte, vinduesgreb og hanke, der kvalitets- og designmæssigt opfylder de krav, det moderne byggeri stiller. Serien er produceret i rustfrit stål, der med sin styrke og finish tåler daglig brug uden at overfladen forandres.

Line 18° serien leveres med det unikke Randi-Plug® system, der som skruesikring forøger effektiviteten og holdbarheden ved montagen af dørgreb. Pluggen styrer skrueerne gennem indvendig roset og låsekasse direkte over i gevindbøsningen i den udvendige roset – en hurtig og sikker montageform med god befæstelse, mindre tidsforbrug og færre omkostninger.

Line 18° er rigtig god kvalitet til prisen. Dørgrebene lever op til kravene i den europæiske standard EN 1906 og er klassificeret som klasse 4 til højfrekvent og daglig brug.



Quality fittings at competitive prices

Line 18° is a comprehensive range of stainless steel fittings, which thanks to their simple, functional design and competitive pricing are ideal for most types of buildings.

The Line 18° range meets the demands of modern building and the designs are up-to-date with current trends. The range is produced in stainless steel, able to tolerate constant use and cleaning without marking the finish.

The Line 18° series is supplied with the unique screw-guide system, the Randi-Plug®, ensuring fast and long-lasting fitting. The system guides the screws directly through the lock body into the threaded bushes on the opposite rose. The plug has a slightly smaller diameter in one particular area, allowing the screw to tap its own thread. The result is fast and secure fitting, with a low time consumption.

The lever handles have been tested in accordance with the specifications of EN 1906 and were classified in the highest category – “grade 4” – for high frequency use.



7020

**Dørgreb i klassisk, funksjonel U-form, ø18 mm rør**

- Leveres i matbørstet rustfritt stål (AISI 304).
- Leveres som standard i sæt til dørtykkelse 40 mm, 40-65 mm eller 65-89 mm, se kodeskema nedenfor.
- Standard firkantstift 8x8 mm.

Lever handle, „Return to Door“ styling, ø18 mm hollow

- Available in satin stainless steel (AISI 304).
- Supplied in pairs, for door thickness 40 mm, 40-65 mm or 65-89 mm, see table of codes below.
- Standard spindle 8x8 mm.

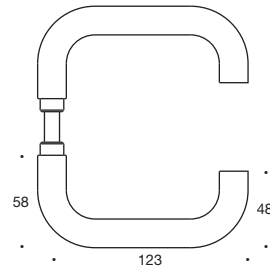
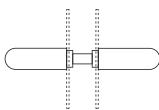
**Produktvarianter · Product variants**

7020.00

ø50x2 mm

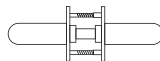
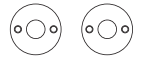
c-c 30 mm
7020.04c-c 38 mm
7020.05

ø52x4 mm

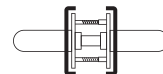
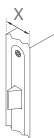
c-c 30 mm & 38 mm
7020.084

Angiv dørtykkelse ved bestilling
Specify door thickness when ordering

| X (mm) | 40 | 40-65 | 65-89 |
|--------|----|-------|-------|
| Code | E | AB | CD |

Ex. 7020.XX.AB

Alle rosetter leveres med patentskruer, løse bøsninger, Randi Plug og træskruer, se side 14.
All roses are supplied with machine screws, threaded bushes, Randi Plug and wood screws, see page 14.

7021



Dørgreb i L-form, $\varnothing 18$ mm rør

- Leveres i matbørstet rustfrit stål (AISI 304).
- Leveres som standard i sæt til dørtykkelse 40 mm, 40-65 mm eller 65-89 mm, se kodeskema nedenfor.
- Standard firkantstift 8x8 mm.

Straight lever handle, $\varnothing 18$ mm hollow

- Available in satin stainless steel (AISI 304).
- Supplied in pairs, for door thickness 40 mm, 40-65 mm or 65-89 mm, see table of codes below.
- Standard spindle 8x8 mm.

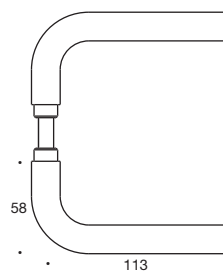

Produktvarianter · Product variants

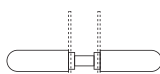

7021.00

$\varnothing 50 \times 2$ mm

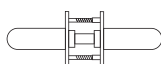

c-c 30 mm
7021.04

c-c 38 mm
7021.05

$\varnothing 52 \times 4$ mm

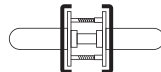

c-c 30 mm & 38 mm
7021.084

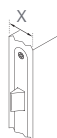

Angiv dørtykkelse ved bestilling
Specify door thickness when ordering

| X (mm) | 40 | 40-65 | 65-89 |
|--------|----|-------|-------|
| Code | E | AB | CD |

Ex. 7021.XX.AB

Alle rosetter leveres med patentskruer, løse bøsninger, Randi Plug og træskruer, se side 14.
All roses are supplied with machine screws, threaded bushes, Randi Plug and wood screws, see page 14.

7024

**Dørgreb i geringsform, ø18 mm rør**

- Leveres i matbørstet rustfrit stål (AISI 304).
- Leveres som standard i sæt til dørtykkelse 40 mm, 40-65 mm eller 65-89 mm, se kodeskema nedenfor.
- Standard firkantstift 8x8 mm.

Straight mitred lever handle, ø18 mm hollow

- Available in satin stainless steel (AISI 304).
- Supplied in pairs, for door thickness 40 mm, 40-65 mm or 65-89 mm, see table of codes below.
- Standard spindle 8x8 mm.

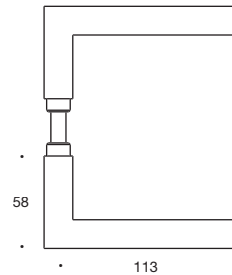
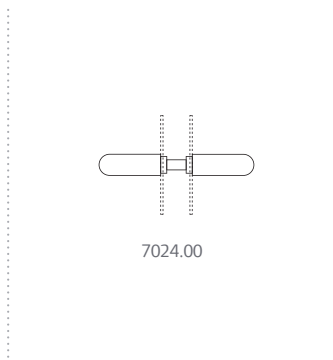
**Produktvarianter · Product variants**

ø50x2 mm

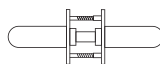
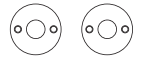

c-c 30 mm
7024.04

c-c 38 mm
7024.05

ø52x4 mm

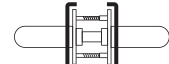

c-c 30 mm & 38 mm
7024.084

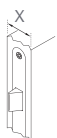

Angiv dørtykkelse ved bestilling
Specify door thickness when ordering

| X (mm) | 40 | 40-65 | 65-89 |
|--------|----|-------|-------|
| Code | E | AB | CD |

Ex. 7024.XX.AB

Alle rosetter leveres med patentskruer, løse bøsninger, Randi Plug og træskruer, se side 14.
All roses are supplied with machine screws, threaded bushes, Randi Plug and wood screws, see page 14.

7060



Dørgreb i buet geringsform, $\varnothing 18$ mm rør

- Leveres i matbørstet rustfrit stål (AISI 304).
- Leveres som standard i sæt til dørtykkelse 40 mm, 40-65 mm eller 65-89 mm, se kodeskema nedenfor.
- Standard firkantstift 8x8 mm.

Mitred lever handle, $\varnothing 18$ mm hollow

- Available in satin stainless steel (AISI 304).
- Supplied in pairs, for door thickness 40 mm, 40-65 mm or 65-89 mm, see table of codes below.
- Standard spindle 8x8 mm.

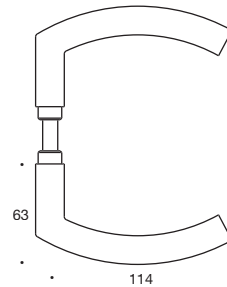

Produktvarianter · Product variants

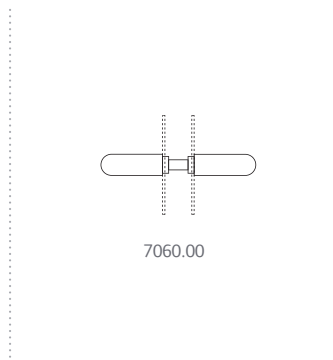

$\varnothing 50 \times 2$ mm

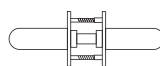

c-c 30 mm
7060.04

c-c 38 mm
7060.05

$\varnothing 52 \times 4$ mm

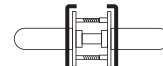

c-c 30 mm & 38 mm
7060.084

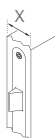

Angiv dørtykkelse ved bestilling
Specify door thickness when ordering

| X (mm) | 40 | 40-65 | 65-89 |
|--------|----|-------|-------|
| Code | E | AB | CD |

Ex. 7060.XX.AB

Alle rosetter leveres med patentskruer, løse bøsninger, Randi Plug og træskruer, se side 14.
All roses are supplied with machine screws, threaded bushes, Randi Plug and wood screws, see page 14.

7062



Dørgreb i enkelt design, ø18 mm rør, inspireret af 1060 grebet fra Randi-Line serien

- Leveres i matbørstet rustfrit stål (AISI 304).
- Leveres som standard i sæt til dørtykkelse 40 mm, 40-65 mm eller 65-89 mm, se kodeskema nedenfor.
- Standard firkantstift 8x8 mm.

Lever handle, ø18 mm hollow, inspired by the 1060 lever handle from the Randi-Line series

- Available in satin stainless steel (AISI 304).
- Supplied in pairs, for door thickness 40 mm, 40-65 mm or 65-89 mm, see table of codes below.
- Standard spindle 8x8 mm.

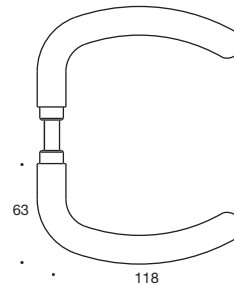

Produktvarianter · Product variants

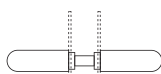

7062.00

ø50x2 mm



c-c 30 mm
7062.04

c-c 38 mm
7062.05

ø52x4 mm



c-c 30 mm & 38 mm
7062.084

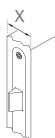

Angiv dørtykkelse ved bestilling
Specify door thickness when ordering

| X (mm) | 40 | 40-65 | 65-89 |
|--------|----|-------|-------|
| Code | E | AB | CD |

Ex. 7062.XX.AB

Alle rosetter leveres med patentskruer, løse bøsninger, Randi Plug og træskruer, se side 14.
All roses are supplied with machine screws, threaded bushes, Randi Plug and wood screws, see page 14.

7065



Dørgreb i buet T-form, $\varnothing 18$ mm rør

- Leveres i matbørstet rustfrit stål (AISI 304).
- Leveres som standard i sæt til dørtykkelse 40 mm 40-65 mm eller 65-89 mm, se kodeskema nedenfor.
- Standard firkantstift 8x8 mm.

Udgår men leveres så længe lager haves.

Lever handle, $\varnothing 18$ mm hollow, curved „T-shape“

- Available in satin stainless steel (AISI 304).
- Supplied in pairs, for door thickness 40 mm, 40-65 mm or 65-89 mm, see table of codes below.
- Standard spindle 8x8 mm.

Discontinued, but can be delivered as long as stock is available.

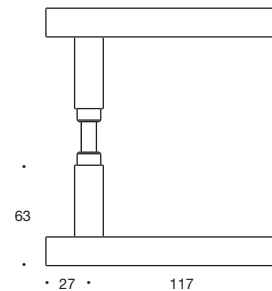

Produktvarianter · Product variants

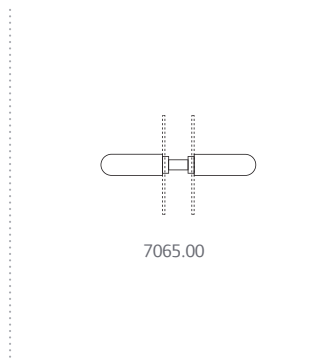

$\varnothing 50 \times 2$ mm

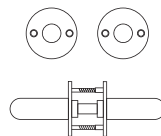

c-c 30 mm
7065.04

c-c 38 mm
7065.05

$\varnothing 52 \times 4$ mm

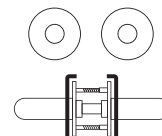

c-c 30 mm & 38 mm
7065.084

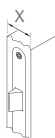

Angiv dørtykkelse ved bestilling
Specify door thickness when ordering

| X (mm) | 40 | 40-65 | 65-89 |
|--------|----|-------|-------|
| Code | E | AB | CD |

Ex. 7065.XX.AB

Alle rosetter leveres med patentskruer, løse bøsninger, Randi Plug og træskruer, se side 14.
All roses are supplied with machine screws, threaded bushes, Randi Plug and wood screws, see page 14.

7080



Drejbar dørknop ø50 mm

- Leveres i matbørstet rustfrit stål (AISI 304).
- Leveres som standard i sæt til dørtykkelse 40-65 mm eller 65-89 mm, se kodeskema nedenfor.
- Standard firkantstift 8x8 mm.

Operating door knob ø50 mm

- Available in satin stainless steel (AISI 304).
- Supplied in pairs, for door thickness 40-65 mm or 65-89 mm, see table of codes below.
- Standard spindle 8x8 mm.

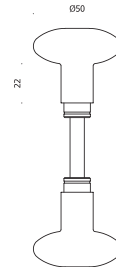

Produktvarianter · Product variants

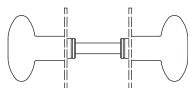

7080.00

ø50x2 mm

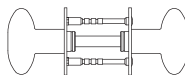
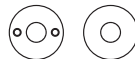

c-c 30 mm
7080.04

c-c 38 mm
7080.05

ø52x4 mm

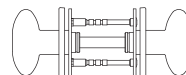

c-c 30 mm & 38 mm
7080.084

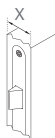

Angiv dørtykkelse ved bestilling
Specify door thickness when ordering

| X (mm) | 40-65 | 65-89 |
|--------|-------|-------|
| Code | AB | CD |

Ex. 7080.XX.AB

Alle rosetter leveres med patentskruer, løse bøsninger og Randi Plug.
All roses are supplied with machine screws, threaded bushes and Randi Plug.

7082



Fast dørknop ø50 mm

- Kan kombineres med alle dørgreb i Line 18® serien.
- Leveres i matbørstet rustfrit stål (AISI 304).
- Leveres i stk. med 8 mm vekselsstift til dørtykkelse 34-58 mm eller 58-82 mm.

Fixed door knob ø50 mm

- Can be used in combination with all Line 18® lever handles.
- Available in satin stainless steel (AISI 304).
- Supplied singly with 8 mm spindle for door thickness 34-58 mm or 58-82 mm.

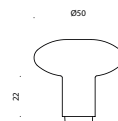

Produktvarianter · Product variants

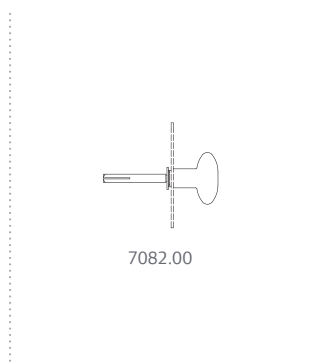

7082.00

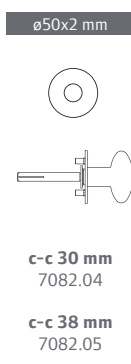

ø50x2 mm

c-c 30 mm
7082.04

c-c 38 mm
7082.05

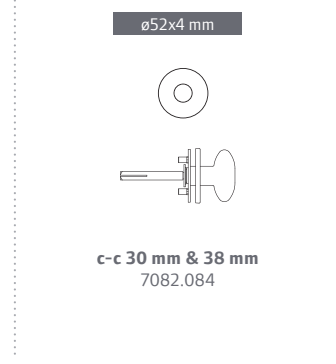

ø52x4 mm

c-c 30 mm & 38 mm
7082.084

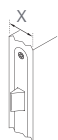

Angiv dørtykkelse ved bestilling
Specify door thickness when ordering

| X (mm) | 34-58 | 58-82 |
|--------|-------|-------|
| Code | AB | CD |

Ex. 7082.XX.AB

Alle rosetter leveres med patentskruer, løse bøsninger, Randi Plug og træskruer, se side 14.
All roses are supplied with machine screws, threaded bushes, Randi Plug and wood screws, see page 14.

7085

**Drejbar, forkrøppet dørknob ø50 mm, til smalprofiløre**

- Leveres i matbørstet rustfrit stål (AISI 304).
- Leveres i sæt til dørtykkelse 40-65 mm eller 65-89mm.
- Standard firkantstift 8x8 mm.

Operating door knob ø50 mm, for narrow profile doors

- Available in satin stainless steel (AISI 304).
- Supplied in pairs, for door thickness 40-65 mm or 65-89 mm
- Standard spindle 8x8 mm.

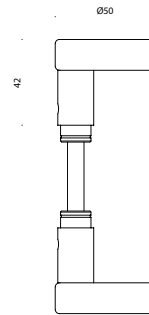
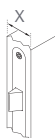
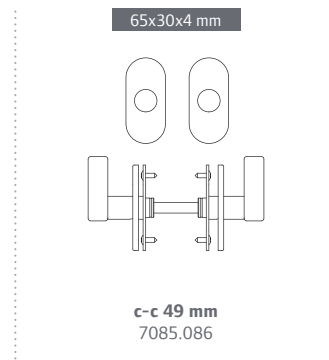
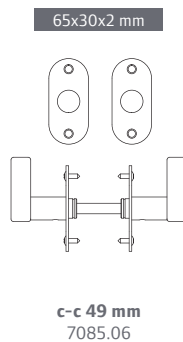
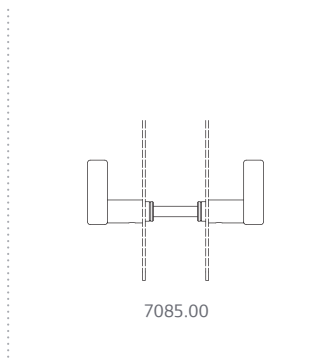
**Produktvarianter · Product variants**

Angiv dørtykkelse ved bestilling
Specify door thickness when ordering

| X (mm) | 40-65 | 65-89 |
|--------|-------|-------|
| Code | AB | CD |

Ex. 7085.XX.AB

Alle rosetter leveres med patentskruer, løse bøsninger, Randi Plug og træskruer, se side 14.
All roses are supplied with machine screws, threaded bushes, Randi Plug and wood screws, see page 14.

7087



Fast, forkrøppet dørknop $\varnothing 50$ mm, til smalprofiløre

- Kan kombineres med alle dørgreb i Line 18® serien.
- Leveres i matbørstet rustfrit stål (AISI 304).
- Leveres i stk. med 8 mm vekselsstift til dørtykkelse 34-58 mm eller 58-82 mm.

Fixed, cranked, door knob $\varnothing 50$ mm, for narrow profile doors

- Can be used in combination with all Line 18® lever handles.
- Available in satin stainless steel (AISI 304).
- Supplied singly with 8 mm spindle for door thickness 34-58 mm or 58-82 mm.

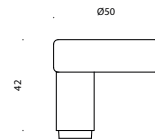

Produktvarianter · Product variants

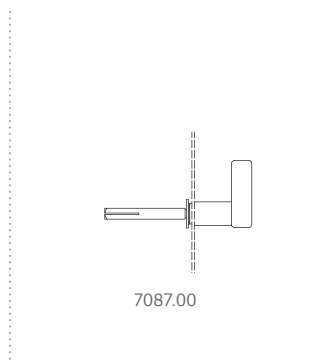

7087.00

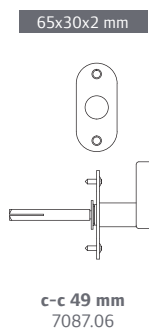

c-c 49 mm
7087.06

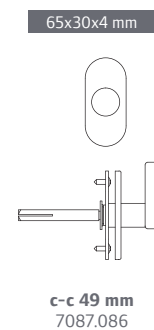

c-c 49 mm
7087.086

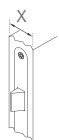

Angiv dørtykkelse ved bestilling
Specify door thickness when ordering

| X (mm) | 34-58 | 58-82 |
|--------|-------|-------|
| Code | AB | CD |

Ex. 7087.XX.AB

Alle rosetter leveres med patentskruer, løse bøsninger, Randi Plug og træskruer, se side 14.
All roses are supplied with machine screws, threaded bushes, Randi Plug and wood screws, see page 14.

7090

**Dørgreb i klassisk coupé-form, ø19 mm rør**

- Leveres i matbørstet rustfrit stål (AISI 304).
- Leveres som standard i sæt til dørtykkelse 40 mm, 40-65 mm eller 65-89 mm, se kodeskema nedenfor.
- Standard firkantstift 8x8 mm.

Lever handle, ø19 mm hollow, classic „coupé-shape“

- Available in satin stainless steel (AISI 304).
- Supplied in pairs, for door thickness 40 mm, 40-65 mm or 65-89 mm, see table of codes below.
- Standard spindle 8x8 mm.

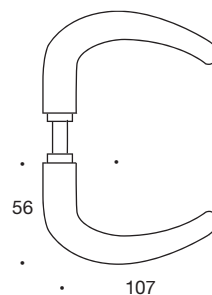
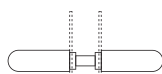
**Produktvarianter · Product variants**

7090.00

ø50x2 mm

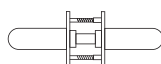
c-c 30 mm
7090.04c-c 38 mm
7090.05

ø52x4 mm

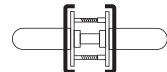
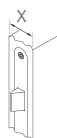
c-c 30 mm & 38 mm
7090.084

Angiv dørtykkelse ved bestilling
Specify door thickness when ordering

| X (mm) | 40 | 40-65 | 65-89 |
|--------|----|-------|-------|
| Code | E | AB | CD |

Ex. 7090.XX.AB

Alle rosetter leveres med patentskruer, løse bøsninger, Randi Plug og træskruer, se side 14.
All roses are supplied with machine screws, threaded bushes, Randi Plug and wood screws, see page 14.

Dørgrebsrosetter - Types of roses



Massiv roset

- Fastmonteret massiv roset, $\varnothing 50 \times 2$ mm. Fås med c-c 30 mm og c-c 38 mm.
- Leveres i sæt inkl. M4 x 84 mm skruer, Torx nr. 15, løse bøsninger samt Randi Plug.

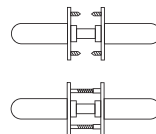

Solid roses

- Solid, attached roses, $\varnothing 50 \times 2$ mm. Available with fixing centres 30 mm and 38 mm.
- Supplied in pairs incl. machine screws M4 x 84 mm, Torx no. 15, threaded bushes and Randi Plug.



Cover roset

- Fastmonteret underroset med cover, $\varnothing 52 \times 4$ mm, ingen synlige skruer. Fås med c-c 30 mm og c-c 38 mm.
- Leveres i sæt inkl. M4 x 84 mm skruer, Torx nr. 15, løse bøsninger, træskruer samt Randi Plug.

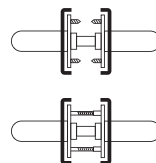

Rose covers

- Attached roses with rose covers, $\varnothing 52 \times 4$ mm, concealed fixing. Available with fixing centres 30 mm and 38 mm.
- Supplied in pairs incl. machine screws M4 x 84 mm, Torx no. 15, threaded bushes, wood screws and Randi Plug.



Smalprofil roset massiv

- Fastmonteret massiv roset, $65 \times 30 \times 2$ mm, med undersænkede huller for træskruer på begge sider, c-c 49 mm.
- Leveres i sæt inkl. træskruer 3,5 x 13 mm, Torx nr. 15.

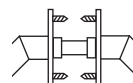

Oval roses, solid

- Solid, attached roses, $65 \times 30 \times 2$ mm. Drilled for countersunk wood screws, fixing centres 49 mm.
- Supplied in pairs incl. wood screws 3,5 x 13 mm, Torx no. 15.



Smalprofil roset med cover

- Fastmonteret underroset med cover, $65 \times 30 \times 4$ mm, ingen synlige skruer, c-c 49 mm.
- Leveres i sæt inkl. træskruer 4 x 16 mm, Torx nr. 15 samt special maskinskrue M5 x 16 mm.

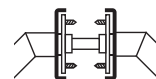

Oval roses with rose covers

- Attached roses with rose covers, $65 \times 30 \times 4$ mm. Concealed fixing, fixing centres 49 mm.
- Supplied in pairs incl. wood screws 4 x 16 mm, Torx no. 15, and special machine screws M5 x 16 mm.

7100

**Massiv roset, ø50x2 mm**

- Leveres i matbørstet rustfrit stål (AISI 304).
- Med løse bøsninger og synlige skruer, centerafstand 30 mm.
- Leveres i sæt inkl. M4x84 mm skruer.

Escutcheons, solid, ø50x2 mm

- Available in satin stainless steel (AISI 304).
- Fixing centres 30 mm, visible screws.
- Supplied in pairs including machine screws M4x84 mm and threaded bushes.
- Fits Scandinavian standard locks.

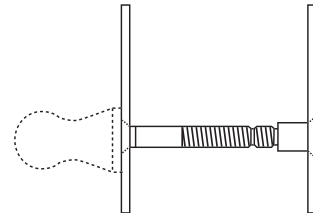
**Produktvarianter · Product variants**

■ 7100.00
Leveres med Randi Plug
Supplied with Randi Plug



■ 7100.03.TA/TG**, dt. 34-50 mm
■ 7100.03.TA/TG-40, dt. 40 mm
■ 7100.03.TA-83, dt. 50-82 mm



■ 7100.01.AM4



■ 7100.01.A



■ 7100.036.TA/TG**



■ 7100.016.AM4



■ 7100.01.AX*



■ 7100.04.M
■ 7100.04.M-40, dt. 40 mm
cc 27 mm



■ 88135
Underlagsskive til rosetbesætning,
ø49 mm, sort gummi.
Vi anbefaler brug af denne ved
montering af rosetbesætninger på
glas-/alu- og ståldøre.

Black rubber washer, ø49 mm, for
use when mounting lever handles
onto glass/aluminium and steel
doors.



■ 7100.02.A



■ 7100.05
■ 7100.05-40, dt. 40 mm



■ 88136
Underlagsskive til dørgrebsroset,
ø49 mm, sort gummi.
Vi anbefaler brug af denne ved
montering af dørgreb på glas-/
alu- og ståldøre.

Black rubber washer, ø49 mm, for
use when mounting lever handles
onto glass/aluminium and steel
doors.

* Fås med konisk cylinderring i forskellige højder: 7, 11, 13, 16, 18, 20 mm.
Som cyl/vrider sæt. Se side 16.

** Toiletbesætning: Kode TA = til ASSA modullås, TG = til mellemdørslås.

* Escutcheons available with cylinder rings in various heights: 7, 11, 13, 16, 18 or 20 mm, in combination with a turn, see page 16.

1100.08.Ax





Konisk cylinderring, indvendig eller udvendig, $\varnothing 53$ mm

- Leveres som standard i rustfrit stål i forskellige højder.
- Huller for M4 skruer, centerafstand 30 mm, leveres i stk.
- Indvendig ring leveres inkl. M4x84 mm skruer.

Tapered cylinder rings, inner or outer, $\varnothing 53$ m

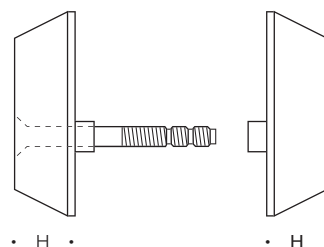
- Available in satin stainless steel in various heights.
- Drilled for M4 screws, fixing centres 30 mm, supplied singly.
- Inside rings supplied incl. machine screws M4x84 mm.
- Fits Scandinavian standard locks.



| | Indvendig Inner | Udvendig Outer |
|--------|---|---|
| mm (h) |  |  |
| 7 | 1100.08.A07.i | 1100.08.A07.u |
| 11 | 1100.08.A11.i | 1100.08.A11.u |
| 13 | 1100.08.A13.i | 1100.08.A13.u |
| 16 | 1100.08.A16.i | 1100.08.A16.u |
| 18 | 1100.08.A18.i | 1100.08.A18.u |
| 20 | 1100.08.A20.i | 1100.08.A20.u |

■ rustfrit stål/stainless steel

1100.08.AR.x



Indvendig, konisk cylinderring for Rokoko cylinder, ø53 mm

- Leveres som standard i matbørstet rustfrit stål (AISI 304).
- Huller for M4 skruer, centerafstand 30 mm.
- Leveres i stk. inkl. M4x84 mm skruer.

Tapered cylinder ring (inner), ø53 mm.

- Available in satin stainless steel (AISI 304).
- Drilled for M4 screws, fixing centres 30 mm.
- Supplied singly including M4x84 mm screws.
- **Fits Scandinavian standard locks.**

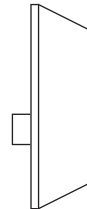

• H •

Produktvarianter · Product variants

| ■ |  |
|--------|---|
| mm (h) | |
| 7 | 1100.08.AR.07 |
| 11 | 1100.08.AR.11 |
| 13 | 1100.08.AR.13 |
| 16 | 1100.08.AR.16 |
| 18 | 1100.08.AR.18 |
| 20 | 1100.08.AR.20 |

7115



Massiv roset, $\varnothing 50 \times 2$ mm

- Leveres i matbørstet rustfrit stål (AISI 304).
- Huller for træskruer, centerafstand 38 mm.
- Leveres i sæt inkl. træskruer 3,5x13 mm.

Escutcheons, solid, $\varnothing 50 \times 2$ mm

- Available in satin stainless steel (AISI 304).
- Drilled for wood screws, fixing centres 38 mm.
- Supplied in pairs including stainless steel wood screws 3,5x13 mm.

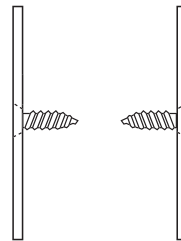

Produktvarianter · Product variants



■ 7115.00



■ 7115.02E



■ 88135

Underlagsskive til rosetbesætning, $\varnothing 49$ mm, sort gummi.
Vi anbefaler brug af denne ved montering af rosetbesætninger på glas-/alu- og ståldøre.

Black rubber washer, $\varnothing 49$ mm, for use when mounting escutcheons onto glass/aluminium and steel doors.



■ 88136

Underlagsskive til dørgrebsroset, $\varnothing 49$ mm, sort gummi.
Vi anbefaler brug af denne ved montering af dørgreb på glas-/alu- og ståldøre.

Black rubber washer, $\varnothing 49$ mm, for use when mounting lever handles onto glass/aluminium and steel doors.

7116

**Massiv roset, ø50x2 mm**

- Leveres i matbørstet rustfrit stål (AISI 304).
- Med løse bøsninger og synlige skruer, centerafstand 38 mm.
- Leveres i sæt inkl. M4x84 mm skruer.

Escutcheons, solid, ø50x2 mm

- Available in satin stainless steel (AISI 304).
- Visible screws, fixing centres 38 mm.
- Supplied in pairs including machine screws M4x84 mm and threaded bushes.

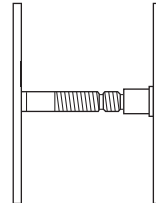
**Produktvarianter · Product variants**

■ 7116.00

Leveres med Randi Plug
Supplied with Randi Plug



■ 7116.02E



- 88135
Underlagsskive til rosetbesætning, ø49 mm, sort gummi.
Vi anbefaler brug af denne ved montering af rosetbesætninger på glas-/alu- og ståldøre.

Black rubber washer, ø49 mm, for use when mounting escutcheons onto glass/aluminium and steel doors.



- 88136
Underlagsskive til dørgrebsroset, ø49 mm, sort gummi.
Vi anbefaler brug af denne ved montering af dørgreb på glas-/alu- og ståldøre.

Black rubber washer, ø49 mm, for use when mounting lever handles onto glass/aluminium and steel doors.

7140



Roset $\varnothing 52 \times 4$ mm med underskilt.

Til brug, hvor der ikke ønskes synlige skruer

- Leveres i matbørstet rustfrit stål (AISI 304).
- Med løse bøsninger, centerafstand 30 mm, ingen synlige skruer.
- Leveres i sæt inkl. M4x84 mm skruer.
- Toiletbesætning standard for dørtykkelse 34-45 mm.

Escutcheons, $\varnothing 52 \times 4$ mm rose covers, concealed fixing

- Available in satin stainless steel (AISI 304).
- Fixing centres 30 mm, no visible screws.
- Supplied in pairs including machine screws M4x84 mm and threaded bushes.
- Bathroom escutcheons: Standard for door thickness 34-45 mm.
- Fits Scandinavian standard locks.

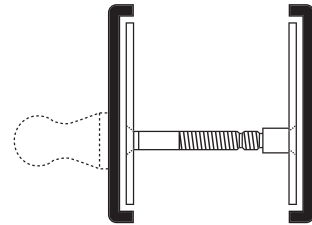

Produktvarianter · Product variants



■ 7140.00

Leveres med Randi Plug
Supplied with Randi Plug



■ 7140.03.TA/TG**, dt. 34-45 mm
■ 7140.03.TA-83, dt. 45-82 mm



■ 7140.01.AM4



■ 7140.01.A



■ 7140.036.TA/TG**



■ 7140.016.AM4



■ 7140.01.AX*



■ 7140.04.M
cc 27 mm



- 88135 Underlagsskive til rosetbesætning, $\varnothing 49$ mm, sort gummi. Vi anbefaler brug af denne ved montering af rosetbesætninger på glas-/alu- og ståldøre.

Black rubber washer, $\varnothing 49$ mm, for use when mounting escutcheons onto glass/aluminium and steel doors.



■ 7140.02.A



■ 7140.05



- 88136 Underlagsskive til dørgrebsrosen, $\varnothing 49$ mm, sort gummi. Vi anbefaler brug af denne ved montering af dørgreb på glas-/alu- og ståldøre.

Black rubber washer, $\varnothing 49$ mm, for use when mounting lever handles onto glass/aluminium and steel doors.

* Fås med konisk cylinderring i forskellige højder: 7, 11, 13, 16, 18, 20 mm.

Som cyl./vrider sæt. Se side 16.

** Toiletbesætning: Kode TA = til ASSA modullås, TG = til mellemdørslås.

* Escutcheons available with cylinder rings in various heights: 7, 11, 13, 16, 18 or 20 mm, in combination with a turn, see page 16.

7145

**Roset ø52x4 mm med underskilt.****Til brug, hvor der ikke ønskes synlige skruer**

- Leveres i mustfrit stål (AISI 304).
- Huller for træskruer, centerafstand 38 mm, ingen synlige skruer.
- Leveres i sæt inkl. træskruer 3,5x13 mm.
- Toiletbesætning standard for dørtykkelse 34-45 mm.

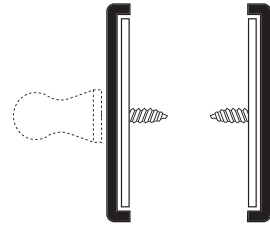
**Escutcheons, ø52x4 mm rose covers, concealed fixing**

- Available in stainless steel (AISI 304).
- Drilled for wood screws, fixing centres 38 mm, no visible screws.
- Supplied in pairs including stainless steel wood screws 3,5x13 mm.
- Bathroom escutcheons: Standard for door thickness 34-45 mm.

Produktvarianter · Product variants

■ 7145.00



■ 7145.02E



■ 7145.03.TG*, dt. 34-45 mm
 ■ 7145.03.TG-83*, dt. 45-82 mm



■ 7145.036.TG*



■ 7145.04.M



■ 7145.05



- 88135
 Underlagsskive til rosetbesætning, ø49 mm, sort gummi.
 Vi anbefaler brug af denne ved montering af rosetbesætninger på glas-/alu- og ståldøre.

Black rubber washer, ø49 mm, for use when mounting escutcheons onto glass/aluminium and steel doors.



- 88136
 Underlagsskive til dørrebsrosset, ø49 mm, sort gummi.
 Vi anbefaler brug af denne ved montering af dørreb på glas-/alu- og ståldøre.

Black rubber washer, ø49 mm, for use when mounting lever handles onto glass/aluminium and steel doors.

* Note! When ordering bathroom escutcheons with 8 mm spindle, use the code TG8. Standard TG is supplied with a 5 mm spindle (for Scandinavia).

7146



Roset $\varnothing 52 \times 4$ mm med underskilt.

Til brug, hvor der ikke ønskes synlige skruer

- Leveres i matbørstet rustfrit stål (AISI 304).
- Med løse bøsninger, centerafstand 38 mm, ingen synlige skruer.
- Leveres i sæt inkl. M4x84 mm skruer.
- Toiletbesætning standard for dørtykkelse 34-45 mm.

Escutcheons, $\varnothing 52 \times 4$ mm rose covers, concealed fixing

- Available in satin stainless steel (AISI 304).
- Fixing centres 38 mm, no visible screws.
- Supplied in pairs including machine screws M4x84 mm and threaded bushes.
- Bathroom escutcheons: Standard for door thickness 34-45 mm.

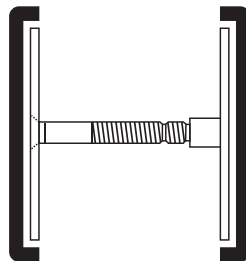

Produktvarianter · Product variants



■ 7146.00

Leveres med Randi Plug
Supplied with Randi Plug



■ 7146.04.M



■ 7146.02E



■ 7146.05



■ 7146.03.TG**



- 88135
Underlagsskive til rosetbesætning, $\varnothing 49$ mm, sort gummi.
Vi anbefaler brug af denne ved montering af rosetbesætninger på glas-/alu- og ståldøre.

Black rubber washer, $\varnothing 49$ mm, for use when mounting escutcheons onto glass/aluminium and steel doors.



■ 7146.036.TG*



- 88136
Underlagsskive til dørgrebsrosset, $\varnothing 49$ mm, sort gummi.
Vi anbefaler brug af denne ved montering af dørgreb på glas-/alu- og ståldøre.

Black rubber washer, $\varnothing 49$ mm, for use when mounting lever handles onto glass/aluminium and steel doors.

* Note! When ordering bathroom escutcheons with 8 mm spindle, use the code TG8. Standard TG is supplied with a 5 mm spindle (for Scandinavia).

7190

**Massiv roset, 65x30x2 mm, til smalprofiløre**

- Leveres i matbørstet rustfrit stål (AISI 304).
- Huller for skruer, centerafstand 49 mm.
- Leveres i sæt inkl. træskruer 3,5x13 mm.

Escutcheons, solid, 65x30x2 mm, for narrow profile doors

- Available in satin stainless steel (AISI 304).
- Drilled for wood screws, fixing centres 49 mm.
- Supplied in pairs including wood screws 3,5x13 mm.

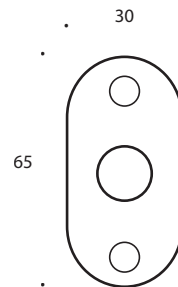
**Produktvarianter · Product variants**

■ 7190.00



■ 7190.01A



■ 7190.02A



■ 7190.02E



■ 7190.04M



■ 7190.05

7194



Roset, 65x30x4 mm, med underskilt, til smalprofiløre

- Leveres i matbørstet rustfrit stål (AISI 304).
- Huller for skruer, centerafstand 49 mm.
- Leveres i sæt inkl. træskruer 4x16 mm samt maskinskruer M5x16 mm.

Escutcheons, 65x30x4 mm rose covers, for narrow profile doors

- Available in satin stainless steel (AISI 304).
- Drilled for wood screws, fixing centres 49 mm.
- Supplied in pairs including wood screws 4x16 mm and machine screws M5x16 mm.

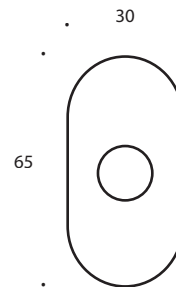

Productvarianten · Variantes



■ 7194.00



■ 7194.01A



■ 7194.02A



■ 7194.04M



■ 7194.02E



■ 7194.05

7220

**Langskilt, 215x55x2 mm**

- Leveres i matbørstet rustfrit stål (AISI 304).
- Dørgrebshul foroven.
- Huller for træskruer eller M4 skruer.
- Leveres i sæt inkl. træskruer 3,5 x 13 mm.

Backplate, 215x55x2 mm

- Available in satin stainless steel (AISI 304).
- Drilled for wood screws or M4 machine screws.
- Supplied in pairs incl. wood screws 3,5 x 13 mm.

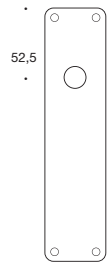
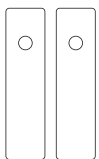
**Produktvarianter · Product variants**

■ 7220.00

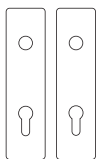
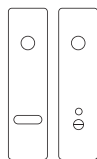
■ 7220.02.EC
■ 7220.02.EG

■ 7220.03.TG

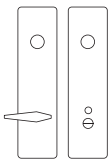

■ 7220.036TG

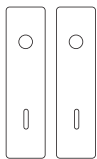

■ 7220.04.MG

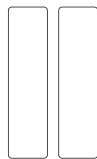

■ 7220.05

Standard X-afstande (afstand mellem dørgrebshul og cylinder/nøglehul/vrider):
C = 92 mm
G = 72 mm
Andre X-afstande, kontakt salgsafdeligen.

Standard X-centres (distance between the centre of the lever hole and the centre of the cylinder/keyhole/turnknob):
C = 92 mm
G = 72 mm
Other X-centres, contact sales department.

7286



Faconskilt, 172x160x2 mm

- Leveres i matbørstet rustfrit stål (AISI 304).
- Dørgrebshul foroven.
- Huller for træskruer eller M4 skruer.
- Leveres i sæt inkl. træskruer 3,5 x 13 mm.

Backplate, 172x160x2 mm

- Available in satin stainless steel (AISI 304).
- Drilled for wood screws or M4 machine screws.
- Supplied in pairs incl. wood screws 3,5 x 13 mm.

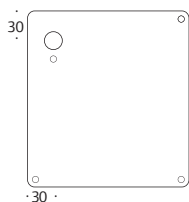

Produktvarianter · Product variants

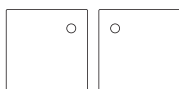

■ 7286.00

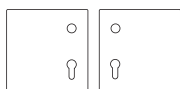

■ 7286.02.EC
■ 7286.02.EG

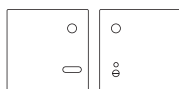

■ 7286.03.TG (L/R)

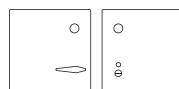

■ 7286.036TG (L/R)



■ 7286.05

Angiv højre = R eller venstre = L som sidste ciffer ved toiletbesætning.
Standard X-afstande (afstand mellem dørgrebshul og cylinder/vrider): C = 92 mm. G = 72 mm
Andre X-afstande, kontakt salgsafdeligen.

Specify right handed = R or left handed = L as last digit when ordering „bathroom“.
Standard X-centres (distance between the centre of the lever hole and the centre of the cylinder/turnknob): C = 92 mm. G = 72 mm
Other X-centres, contact sales department.

7290

**Langskilt, 235x35x2 mm**

- Leveres i matbørstet rustfrit stål (AISI 304).
- Dørgrebshul foroven.
- Huller for træskruer eller M4 skruer.
- Leveres i sæt inkl. træskruer 3,5 x 13 mm.

Backplate, 235x35x2 mm

- Available in satin stainless steel (AISI 304).
- Drilled for wood screws or M4 machine screws.
- Supplied in pairs incl. wood screws 3,5 x 13 mm.

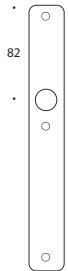
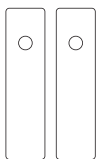
**Produktvarianter · Product variants**

■ 7290.00

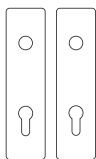
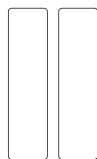
■ 7290.02.EC
■ 7290.02.EG

■ 7290.05

Standard X-afstande (afstand mellem dørgrebshul og cylinder):
C = 92 mm
G = 72 mm
Andre X-afstande, kontakt salgsafdeligen.

Standard X-centres (distance between the centre of the lever hole and the centre of the cylinder):
C = 92 mm
G = 72 mm
Other X-centres, contact sales department.

7320



Langskilt, 215x55x2 mm

- Leveres i matbørstet rustfrit stål (AISI 304).
- Dørgrebshul forneden.
- Huller for træskruer eller M4 skruer.
- Leveres i sæt inkl. træskruer 3,5 x 13 mm.

Backplate, 215x55x2 mm

- Available in satin stainless steel (AISI 304).
- With lever position at the bottom for handle.
- Drilled for wood screws or M4 machine screws.
- Supplied in pairs incl. wood screws 3,5 x 13 mm.
- Fits Scandinavian standard locks.

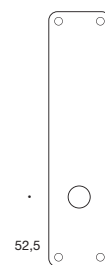

Produktvarianter · Product variants

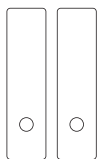

■ 7320.00

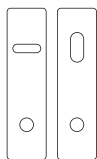

■ 7320.01.AA

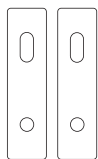

■ 7320.02.AA

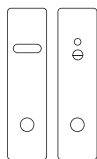

■ 7320.03.TA, dt. 34-50 mm
■ 7320.03TA-83, dt. 50-82 mm

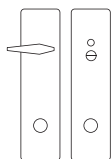

■ 7320.036.TA



■ 7320.05

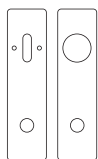

■ 7320.01.HA

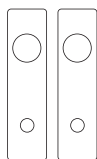

■ 7320.02.HA



■ 61391

Eventuel konisk cylinderring bestilles særskilt. Se side 16.
X-afstand (afstand mellem dørgrebshul og cylinder/vrider): = 105 mm

Tapered cylinder rings should be ordered separately. See page 16.
X-centres (distance between the centre of the lever hole and the centre of the cylinder/turnknob): = 105 mm

Underlagsskive til langskilte, 214 x 54 mm, sort gummi.
Vi anbefaler brug af denne ved montering af langskilte, 1201, 1301, 7220 og 7320 på glas-/alu- og ståldøre.

Black rubber washer, 214 x 54 mm, for use when mounting backplates no 1201, 1301, 7220 and 7320 onto glass/aluminium and steel doors.

7330

**Langskilt, 250x60x2 mm**

- Leveres i matbørstet rustfrit stål (AISI 304).
- Dørgrebshul forneden.
- Huller for træskruer eller M4 skruer.
- Leveres i sæt inkl. træskruer 3,5 x 13 mm.

Backplate, 250x60x2 mm

- Available in satin stainless steel (AISI 304).
- With lever position at the bottom for handle.
- Drilled for wood screws or M4 machine screws.
- Supplied in pairs incl. wood screws 3,5 x 13 mm.
- **Fits Scandinavian standard locks.**

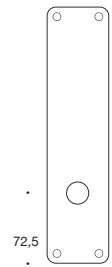
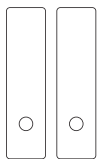
**Produktvarianter · Product variants**

■ 7330.00

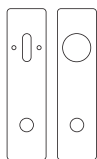

■ 7330.01.HA

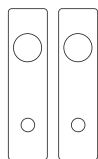

■ 7330.02.HA

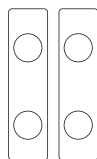

■ 7330.02.HA.HA

Eventuel konisk cylinderring bestilles særskilt. Se side 16.

X-afstand (afstand mellem dørgrebshul og cylinder/vrider) = 105 mm

Tapered cylinder rings should be ordered separately. See page 16.

X-centres (distance between the centre of the lever hole and the centre of the cylinder/turnknob) = 105 mm



Line 18° er en komplet serie af beslag, der med sit enkle, funktionelle design og gunstige prisniveau henvender sig de fleste bygningsformer, lige fra kontorbyggeri til boliger. Serien er produceret i rustfrit stål og leveres med det unikke Randi-Plug® system – en hurtig og sikker montageform med god befæstigelse, mindre tidsforbrug og færre omkostninger.

Line 18° is a complete range of fittings in a simple, functional design and at an attractive price level which appeals to use for most types of buildings – from offices to residential ones. The products are produced of stainless steel and are delivered with the unique Randi-Plug® system – a quick and safe screw-guide system which ensures fast and long-lasting fitting with low time consumption and reduced costs.

Tietgenkollegiet / Tietgen dormitory

Architect: Lundgaard & Tranberg

7385

**Faconskilt, 172x160x2 mm**

- Leveres i matbørstet rustfrit stål (AISI 304).
- Dørgrebshul forneden.
- Huller for træskruer eller M4 skruer.
- Leveres i sæt inkl. træskruer 3,5 x 13 mm.

Backplate, 172x160x2 mm

- Available in satin stainless steel (AISI 304).
- With lever position at the bottom for handle.
- Drilled for wood screws or M4 machine screws.
- Supplied in pairs incl. wood screws 3,5 x 13 mm.
- **Fits Scandinavian standard locks.**

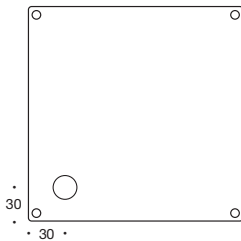
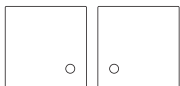
**Produktvarianter · Product variants**

■ 7385.00

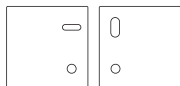

■ 7385.01.AA (L/R)

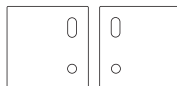

■ 7385.02.AA

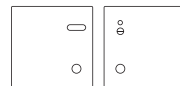

■ 7385.03.TA (L/R)

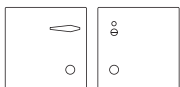

■ 7385.036.TA (L/R)



■ 7385.05

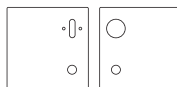

■ 7385.01.HA (L/R)

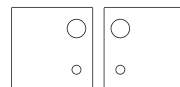

■ 7385.02.HA

Eventuel konisk cylinderring bestilles særskilt. Se side 16.

Angiv højre = R eller venstre = L som sidste ciffer ved toiletbesætning eller cylinder/vrider.

X-afstand (afstand mellem dørgrebshul og cylinder/vrider): = 105 mm.

Tapered cylinder rings should be ordered separately. See page 16.

Specify right handed = R or left handed = L as last digit when ordering „bathroom“ or „cylinder/turn“.

X-centres (distance between the centre of the lever hole and the centre of the cylinder/turnknob): = 105 mm.

7390



Langskilt, 235x35x2 mm, til smalprofiløre

- Leveres som standard i matbørstet rustfrit stål (AISI 304).
- Dørgrebshul forneden.
- Huller for træskruer eller M4 skruer.
- Leveres i sæt inkl. træskruer 3,5x13 mm. Varianter med konisk cylinderafdækning leveres med M4x84 mm skruer Torx nr. 15, løse bøsninger samt Randi-Plug®
- *Vi anbefaler brug af underlagsskive nr. 61390 ved montering af skilte på glas-/alu- og ståldøre.*

Backplate, 235x35x2 mm, for narrow profile doors

- Available in satin stainless steel (AISI 304).
- With lever position at the bottom for handle.
- Drilled for wood screws or M4 screws.
- Supplied in pairs including wood screws 3,5x13 mm. Variants with tapered cylinder ring are supplied with machine screws M4x84 mm Torx no 15, loose bushes and Randi-Plug®.
- *We recommend use of rubber washer no 61390 for mounting on glass/aluminium and steel doors.*
- **Fits Scandinavian standard locks.**

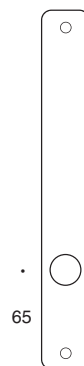

Produktvarianter · Product variants

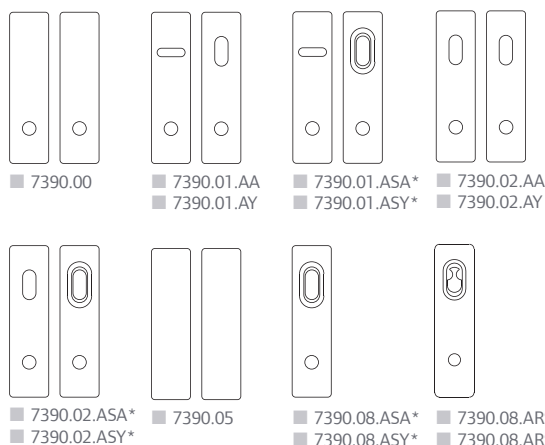

Standard X-afstande (afstand mellem dørgrebshul og cylinder/vrider):
 A = 105 mm
 Y = 115 mm

Standard X-centres (distance between the centre of the lever hole and the centre of the cylinder/turnknob):
 A = 105 mm
 Y = 115 mm

* Skilte med konisk cylinderafdækning kan leveres i højderne 9, 11, 13, 15 og 18 mm til oval cylinder og i højderne 9, 13 og 18 mm til Rokoko cylinder. (Inkl. skiltets tykkelse på 2 mm)

* Backplates with tapered cylinder ring are available in heights 9, 11, 13, 15 and 18 mm for oval shaped cylinder and heights 9, 13 and 18 mm for Rokoko cylinder. (Incl. 2 mm height of the backplate)

61390

Underlagsskive til smalprofilskilte, 228 x 30 mm, sort gummi.
 Vi anbefaler brug af denne ved montering af smalprofilskilte, 1390, 1391, 1392, 7390, 7392 på glas-/alu- og ståldøre.

Black rubber washer, 228 x 30 mm, for use when mounting backplates no 1390, 1391, 1392, 7390, 7392 onto glass/aluminium and steel doors.

7392

**Smalprofilskit, 235x35x2 mm**

- Leveres i matbørstet rustfrit stål (AISI 304).
- Dørgrebshul fornedet.
- Huller for træskruer eller M4 skruer.
- Leveres i sæt inkl. træskruer 3,5x13 mm. Varianter med konisk cylinderafdækning leveres med M4x84 mm skruer Torx nr. 15, løse bøsninger samt Randi-Plug®
- Vi anbefaler brug af underlagsskive nr. 61390 ved montering af skilte på glas-/alu- og ståldøre.

Backplate, 235x35x2 mm

- Available in satin stainless steel (AISI 304).
- With lever position at the bottom for handle.
- Drilled for wood screws or M4 machine screws.
- Supplied in pairs including wood screws 3,5x13 mm. Variants with tapered cylinder ring are supplied with machine screws M4x84 mm Torx no 15, loose bushes and Randi-Plug®.
- We recommend use of rubber washer no 61390 for mounting on glass/aluminium and steel doors.
- Fits Scandinavian standard locks.

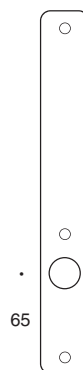
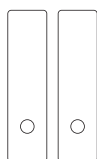
**Produktvarianter · Product variants**

■ 7392.00

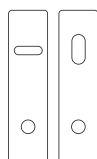
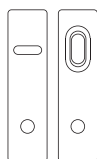
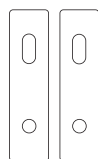
■ 7392.01.AA
■ 7392.01.AY■ 7392.01.ASA*
■ 7392.01.ASY*■ 7392.02.AA
■ 7392.02.AY

Standard X-afstande (afstand mellem dørgrebshul og cylinder/vrider):
A = 105 mm
Y = 115 mm

Standard X-centres (distance between the centre of the lever hole and the centre of the cylinder/turnknob):
A = 105 mm
Y = 115 mm

* Skilte med konisk cylinderafdækning kan leveres i højderne 9, 11, 13, 15 og 18 mm til oval cylinder og i højderne 9, 13 og 18 mm til Rokoko cylinder. (Inkl. skiltets tykkelse på 2 mm)

* Backplates with tapered cylinder ring are available in heights 9, 11, 13, 15 and 18 mm for oval shaped cylinder and heights 9, 13 and 18 mm for Rokoko cylinder. (Incl. 2 mm height of the backplate)

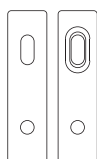
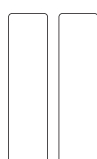
■ 7392.02.ASA*
■ 7392.02.ASY*

■ 7392.05

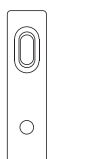
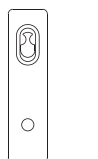
■ 7392.08.ASA*
■ 7392.08.ASY*■ 7392.08.ARSA*
■ 7392.08.ARSY***61390**

Underlagsskive til smalprofilskitte, 228 x 30 mm, sort gummi. Vi anbefaler brug af denne ved montering af smalprofilskitte, 1390, 1391, 1392, 7390, 7392 på glas-/alu- og ståldøre.

Black rubber washer, 228 x 30 mm, for use when mounting backplates no 1390, 1391, 1392, 7390, 7392 onto glass/aluminium and steel doors.

7518



Lige rørhank, $\varnothing 18$ mm

- Leveres i matbørstet rustfrit stål (AISI 304).
- Leveres i stk. ekskl. bolte. Montagesæt bestilles særskilt, se side 42.

Straight pull handle, $\varnothing 18$ mm

- Available in satin stainless steel (AISI 304).
- Supplied singly without screws. Fixing sets should be ordered separately, see page 42.

| CC | 125 mm | 175 mm | 300 mm |
|---------------------|----------|----------|----------|
| $\varnothing 18$ mm | 7518.125 | 7518.175 | 7518.300 |

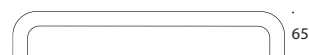

7525



Lige rørhank, $\varnothing 25$ mm

- Leveres i matbørstet rustfrit stål (AISI 304).
- Leveres i stk. ekskl. bolte. Montagesæt bestilles særskilt, se side 42.

Straight pull handle, $\varnothing 25$ mm

- Available in satin stainless steel (AISI 304).
- Supplied singly without screws. Fixing sets should be ordered separately, see page 42.

| CC | 200 mm | 300 mm | 450 mm |
|---------------------|----------|----------|----------|
| $\varnothing 25$ mm | 7525.200 | 7525.300 | 7525.450 |

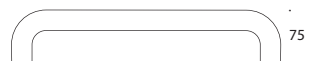

7535

**Forkrøppet rørhank, ø25 mm**

- Leveres i matbørstet rustfrit stål (AISI 304).
- Leveres i stk. ekskl. bolte. Montagesæt bestilles særskilt, se side 42.

Cranked pull handle, ø25 mm

- Available in satin stainless steel (AISI 304).
- Supplied singly without screws. Fixing sets should be ordered separately, see page 42.

| CC | 200 mm | 300 mm | 450 mm |
|--------|----------|----------|----------|
| Ø25 mm | 7535.200 | 7535.300 | 7535.450 |

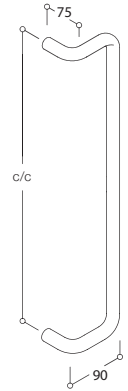

7590



■ 7590.00

Skydedørshank ø18x125 mm, monteret på skilt 175x65x2 mm

- Leveres som standard i matbørstet rustfrit stål (AISI 304).
- Leveres i stk. inkl. træskruer 3,5x16 mm.

Pull handle, ø18x125 mm, fixed on backplate 175x65x2 mm

- Available in satin stainless steel (AISI 304).
- Supplied singly incl. wood screws 3,5x16 mm.

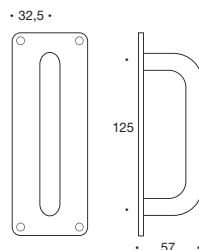

7600/7601



Dørstopper $\varnothing 22$ mm, højde 50, 85, 100, 150, 200 mm, flange $\varnothing 50 \times 2$ mm. Sort gummienslag $\varnothing 30 \times 22$ mm

- Leveres i matbørstet rustfrit stål (AISI 304).
- Leveres i stk. inkl. plug og skrue.

Door stop, $\varnothing 22$ mm, height 50, 85, 100, 150, 200 mm, rose $\varnothing 50 \times 2$ mm. Rubber buffer $\varnothing 30 \times 22$ mm

- Available in satin stainless steel (AISI 304).
- Supplied singly incl. plug and screw.

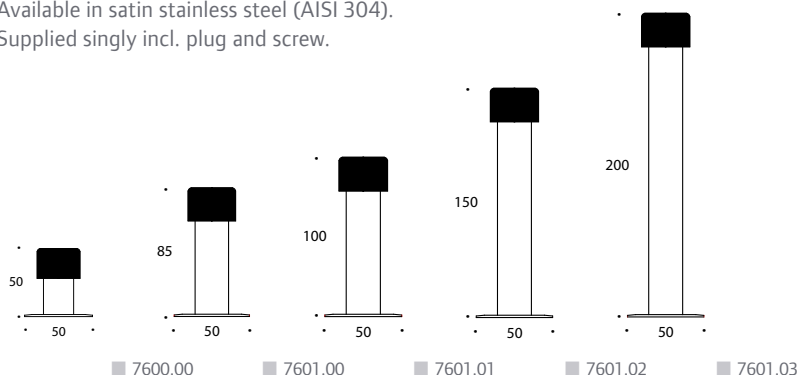

7602



■ 7602.00

Dørstopper $\varnothing 40$ mm, højde 12 mm, med gråt gummienslag. Hul $\varnothing 5$ mm for skrue

- Leveres i matbørstet rustfrit stål (AISI 304).
- Leveres i stk. inkl. plug og skrue.

Door stop, $\varnothing 40$ mm, height 12 mm, with grey rubber buffer. Drilled for $\varnothing 5$ mm screw

- Available in satin stainless steel (AISI 304).
- Supplied singly incl. plug and screw.

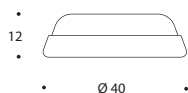

7604



■ 7604.00

Dørstopper ø19 mm, højde 33-77-100-125-150 mm, med sort gummienslag, flange ø32x2 mm

- Leveres i matbørstet rustfrit stål (AISI 304).
- Leveres i stk. inkl. plug og skrue.

Door stop, ø19 mm, height 33-77-100-125-150 mm, with black rubber buffer, rose ø32x2 mm

- Available in satin stainless steel (AISI 304).
- Supplied singly incl. plug and screw.

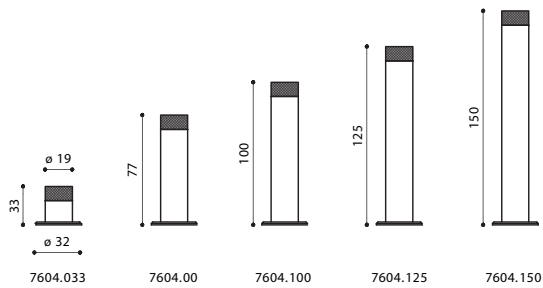

7607



■ 7607.00

Dørstopper ø45 mm, højde 25 mm, med sort gummienslag. Hul for træskrue 5,5 mm

- Leveres i matbørstet rustfrit stål (AISI 304).
- Leveres i stk. inkl. plug og skrue.

Door stop, ø45 mm, height 25 mm, with black rubber buffer. Drilled for 5,5 mm wood screw

- Available in satin stainless steel (AISI 304).
- Supplied singly incl. plug and screw.

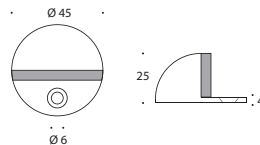

7606



■ 7606.00

Dørstopper ø80 mm, højde 16 mm, med sort gummianslag. Hul for 5 mm træskrue

- Leveres i matbørstet rustfrit stål (AISI 304).
- Leveres i stk. inkl. plug og skrue.

Door stop, ø80 mm, height 16 mm, with black rubber buffer. Drilled for 5 mm wood screw

- Available in satin stainless steel (AISI 304).
- Supplied singly incl. plug and screw.

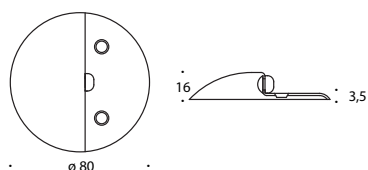

7608



■ 7608.00

Dørstopper ø80 mm, højde 30 mm, med sort gummianslag. Hul for 5 mm træskrue

- Leveres i matbørstet rustfrit stål (AISI 304).
- Leveres i stk. inkl. plug og skruer.

Door stop, ø80 mm, height 30 mm, with black rubber buffer. Drilled for 5 mm wood screw

- Available in satin stainless steel (AISI 304).
- Supplied singly incl. plug and screws.

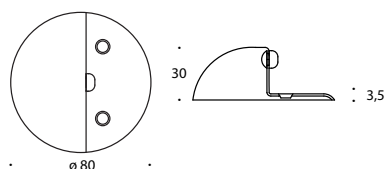



Toves Gaard, Frederiksberg

Architect: Entasis, København

7701



Vinduesgreb i L-form, ø14 mm, på roset 20x65x3 mm

- Leveres i massiv matbørstet rustfrit stål (AISI 304).
- Huller for M5 skruer eller 5 mm træskruer, centerafstand 43 mm.
- Leveres i stk. inkl. M5 skruer.
- Leveres med standardstift 7x7 mm eller 8x8 mm.

Straight window handle, solid, ø14 mm, on rose 20x65x3 mm.

- Available in solid, satin stainless steel (AISI 304).
- Drilled for M5 screws or 5 mm wood screws, fixing centres 43 mm.
- Supplied singly incl. M5 screws.
- Supplied with spindle 7x7 mm or 8x8 mm.

| | |
|-----------|---------|
| □ | |
| 7x7x43 mm | 7701.01 |
| 8x8x43 mm | 7701.00 |

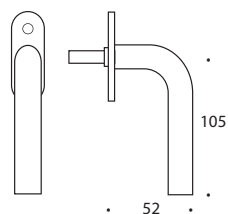

7706



Forkrøppet vinduesgreb, ø14 mm, på roset 20x65x3 mm

- Leveres i massiv matbørstet rustfrit stål (AISI 304).
- Huller for M5 skruer eller 5 mm træskruer, centerafstand 43 mm.
- Leveres i stk. inkl. M5 skruer.
- Leveres med standardstift 7x7 mm eller 8x8 mm.

Cranked window handle, ø14 mm, on rose 20x65x3 mm

- Available in solid, satin stainless steel (AISI 304).
- Drilled for M5 screws or 5 mm wood screws, fixing centres 43 mm.
- Supplied singly incl. M5 screws.
- Supplied with spindle 7x7 mm or 8x8 mm.

| | |
|-----------|---------|
| □ | |
| 7x7x43 mm | 7706.01 |
| 8x8x43 mm | 7706.00 |

Angiv højre = R eller venstre = L variant.
Illustrationen viser højre.

Specify right handed = R or left handed = L when ordering.
Illustration shows right handed.

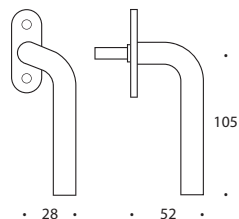

7743

Vinduesgreb med momentstop, $\varnothing 19$ mm rør, stift 7x7x35 mm

- Leveres i rustfrit stål (AISI 304).
- Med momentstop 90°-180° til dreje/kip.
- Fastmonteret roset med cover, 30x65x12 mm.
- Huller for M5 skruer eller træskruer, centerafstand 43 mm.
- Leveres i stk. inkl. M5 skruer.

Straight window handle $\varnothing 19$ mm hollow. Spindle 7x7x35 mm

- Available in stainless steel (AISI 304).
- Supplied with arrester at 90°-180° for turn/tilt.
- With attached rose and rose cover 30x65x12 mm, for concealed fixing.
- Drilled for M5 screws or wood screws, fixing centres 43 mm.
- Supplied singly including M5 screws.



7x7x35 mm 7743.01-35

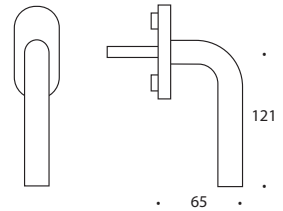

60045



Glastilbehør til Line 18° hanke.
Leveres i sæt. Hul i glas: \varnothing 12 mm.

Fittings for installation of Line
18° pull handles on glass doors.
Supplied in pairs.
Bores in glass: \varnothing 12 mm

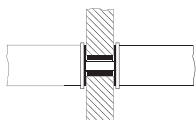

73050



Rosetter til montagesæt, 2 stk.

Washer for fixing sets.
Supplied in pairs.

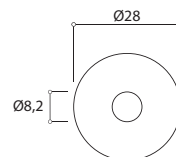

73045T



Bøsning M8 til ensidig montage af Line 18° hanke.
Til dørtykkelse over 30 mm. Leveres i sæt.

M8 screws for face fixing of Line 18° pull handles.
For doors thicker than 30 mm. Supplied in pairs.

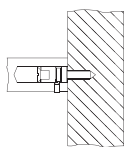

73046GX



Gevindskruer M8 til montage af Line
18° hanke. Leveres i sæt.

M8 screw for bolt through fixing of
Line 18° pull handles. Supplied in pairs.

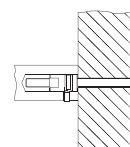

| | |
|--------------|----------|
| Dt. 10-22 mm | 73046GA |
| Dt. 23-42 mm | 73046GBC |
| Dt. 43-54 mm | 73046GD |
| Dt. 55-78 mm | 73046GEF |

73040SX



Sammenspændingsbolt M8 til parvis
montage af Line 18° hanke. Leveres i sæt.

M8 assembly screws, back to back fixing
of Line 18° pull handles. Supplied in pairs.

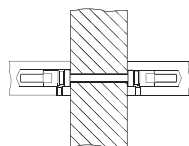

| | |
|--------------|-----------|
| Dt. 10-42 mm | 73040SABC |
| Dt. 43-78 mm | 73040SDEF |

1988



Line 18 sortimentsbox

Line 18 accessoriebox

64089-64091

M4 patentskrue, Torx nr. 15
Forniklet

| | |
|-------------|-------|
| M4 x 84 mm | 64090 |
| M4 x 120 mm | 64089 |
| M4 x 39 mm | 64091 |

M4 machine screw, Torx nr. 15
Nickel platedSælges kun i antal deleligt med 20 stk. fx. 64089-020.
Sold only in qty. divisible by 20 pcs. e.g. 64089-020.

82616-82618

Firkantpind 8x8 mm, til montage af
Line 18® dørgreb. El-forzinket.

| | |
|-----------------|-------|
| 8x8x131 mm (CD) | 82616 |
| 8x8 107 mm (AB) | 82617 |
| 8x8x100mm | 82618 |

Spindle 8x8 mm, for Line 18® lever
handles. Electro zinc-coated.

F60002

Bøsning til M4 patentskrue, forniklet.
Til Line 18® dørgreb, rosetter og skilte.Threaded bush for M4 machine screw, nickel plated.
For Line 18® lever handles, roses and backplates.Sælges kun i antal deleligt med 20 stk. fx. F60002-020.
Sold only in qty. divisible by 20 pcs. e.g. F60002-020.

55263-55278



Gummianslag til Line 18 dørstop.

Rubber buffer for Line 18 doorstops.

| | |
|-----------|-------|
| 7600/7601 | 55263 |
| 7602 | 55265 |
| 7606/7608 | 55266 |
| 7604 | 55278 |

1. ANVENDELSE

1. Nærværende almindelige salgs- og leveringsbetingelser (januar 2020) for Randi A/S er gældende for ethvert salg fra Randi A/S, medmindre de udtrykkeligt er fraveget eller modificeret ved anden skriftlig aftale.
- 1.2 Specielle købsbetingelser eller specifikke krav til det købte fra købers side, anført i f.eks. købers ordreafgivelse eller i købers indkøbsbetingelser, er ikke bindende for Randi A/S, medmindre Randi A/S udtrykkeligt skriftligt har erklæret sig indforstået med vilkårene.

2. ORDREN

- 2.1 I det omfang, at Randi A/S afgiver tilbud, må tilbudsmotageren selv kontrollere, om tilbuddet svarer til behovet med hensyn til mængde og specifikationer.
- 2.3 I det omfang, Randi A/S fremsender skriftlig ordrebekræftelse, anses aftalen mellem Randi A/S og køber først for at være bindende for Randi A/S på dette tidspunkt, uanset om Randi A/S forinden har fremsendt tilbud, der efterfølgende er accepteret af køber.
- 2.4 Købers eventuelle indsigelser mod en eventuel ordrebekræftelses indhold skal foreligge skriftligt og være Randi A/S i hænde senest 8 dage efter datoen for ordrebekræftelsen, dog senest ved leverance.
- 2.5 Købers annullering, returnering eller ændring af en ordre kan kun ske med Randi's skriftlige samtykke. Såfremt en sådan skriftlig samtykke vedrørende returnering foreligger, er køber forpligtet til at levere de pågældende varer franko hos Randi, Mirabellevej 3, 8930 Randers NØ, vedlagt følgeseddel med påført fakturadato og -nummer. Til dækning af ekspeditionsomkostninger beregnes 30% af fakturaprisen for de pågældende varer, dog minimum kr. 100, hvortil kommer tillæg for evt. oppudsning og lignende.

3. LEVERING

- 3.1 Leveringsklausulen er Ex Works, Randers, (INCOTERMS 2000), medmindre andet er aftalt skriftligt i det konkrete tilfælde. Såfremt dette er tilfældet, vil den pågældende leveringsklausul skulle forstås i henhold til INCOTERMS (2000) i det omfang, at dette er muligt.
- 3.2 Medmindre der udtrykkeligt fremgår andet af ordrebekræftelsen, er det angivne leveringstidspunkt omtrentligt. Randi kan kræve leveringstiden udskudt ved enhver ændring i eller tilføjelse til købsordren.
- 3.3 Den af Randi meddelte leveringstid forudsætter, at køber rettidigt har opfyldt alle nødvendige eller aftalte formaliteter eller vilkår.
- 3.4 Randi A/S forbeholder sig retten til at levere i rater.

4. FORSINKELSE

- 4.1 Såfremt Randi A/S ikke leverer i overensstemmelse med det til køber aftalte leveringstidspunkt eller inden rimelig tid herefter, og uden at der foreligger en force majeure-situation, jf. pkt. 10, er køber berettiget til ved skriftlig meddelelse til Randi A/S at kræve levering og fastsætte en endelig frist på minimum 30 arbejdsdage regnet fra det tidspunkt, hvor køber gør denne ret gældende. Såfremt levering ikke sker inden for den af køber fastsatte frist, er køber berettiget til at hæve aftalen, såfremt levering ikke finder sted inden yderligere 10 arbejdsdage efter, at påkrav herom er fremsat.
- 4.2 Udover den i pkt. 4.1 aftalte hævebeføjelse kan køber ikke gøre andre misligholdelsesbeføjelser ved forsinkelse gældende overfor Randi A/S og kan derfor eksempelvis ikke rejse krav om erstatning af nogen art. Køber har således ej heller mulighed for at hæve tidligere eller efterfølgende salgsaftaler i tilfælde af forsinkelse på en leverance.

5. BETALING

- 5.1 Medmindre andet er aftalt, er betalingsbetingelsen netto kontant.
- 5.2 Såfremt betaling ikke finder sted rettidigt, tilskrives morarenter fra fakturadatoen af det til enhver tid skyldige beløb inklusive tidligere tilskrevne renter, omkostninger m.v. med 1,5% pr. påbegyndt måned.
- 5.3 Overholder køber ikke de aftalte betalingsbetingelser for en eller flere leverancer, eller misligholder køber på anden måde en købsaftale med Randi A/S, herunder standser sine betalinger, har Randi A/S udover sin øvrige misligholdelsesbeføjelser ret til øjeblikkeligt at standse yderligere leverancer, og Randi A/S's fulde tilgodehavende forfalder straks til betaling.
- 5.4 Køber er uberettiget til at tilbageholde nogen del af købesummen som sikkerhed for opfyldelse af eventuelle modkrav vedrørende andre leverancer, og sådan tilbageholdelse vil være at betragte som væsentlig misligholdelse af indgåede købsaftaler.

6. EJENDOMSFORBEHOLD

- 6.1 Randi A/S forbeholder sig ejendomsretten til enhver leverance indtil betaling er sket.

7. VEJLEDNINGER, BROCHURER M.V.

- 7.1 Oplysninger, data m.v. givet af Randi A/S i kataloger, brochurer og andet trykmateriale er vejledende og alene bindende for Randi A/S, såfremt købsaftalen konkret henviser til sådanne oplysninger eller data.
- 7.2 Køber har det fulde ansvar for udvælgelsen af det købte og for, at det købte kan opnå de for køberen forventede resultater, samt det købte kan fungere i købers påtænkte driftsmiljø.

8. MANGLER

- 8.1 Køber skal undersøge det købte for mangler straks ved modtagelsen.
- 8.2 Ved købers konstatering af mangler skal køber omgående skriftligt overfor Randi A/S beskrive og specificere den påberåbte mangel. Enhver reklamation over mangler, der er eller burde være opdaget ved køberens kontrol af det købte, skal være modtaget af Randi A/S uden ugrundet ophold efter levering af det købte, dog senest i tilstrækkelig tid før det købtets brug, således at Randi A/S forinden kan nå at tage stilling til reklamationen. Overholder køber ikke førnævnte reklamationsregler, kan køber ikke påberåbe sig manglen.
- 8.3 Ethvert mangelskrav, uanset art, skal være gjort gældende inden for de reklamationsfrister, som fremgår af nærværende pkt. 8. Undlader køber dette, kan køber ikke efterfølgende påberåbe sig manglen.

- 8.4 Køber er forpligtet til nøje at iagttage de i Randi A/S's brochure- og produktmateriale eller i korrespondance indeholdte anvisninger eller mundtligt angivne oplysninger om valg, anvendelse og vedligeholdelse af det købte.
- 8.5 Såfremt der påvises mangler, der kan gøres gældende overfor Randi A/S, er Randi A/S efter eget valg berettiget og forpligtet til enten at foretage omlevering, afhjælpe manglen eller acceptere at give køber et forholdsmæssigt afslag i den aftalte købesum. Køber er herved fuldt og endeligt fyldestgjort for ethvert krav som følge af manglen.
- 8.6 Randi A/S afgiver inden rimelig tid efter modtagelsen af en berettiget reklamation erklæring om sit valg ifølge pkt.8.5. Såfremt Randi A/S ikke inden 10 arbejdsdage efter afgivelse af sin erklæring til køber opfylder sine forpligtelser i henhold til pkt. 8.5, kan køber skriftligt give Randi A/S en sidste rimelig frist for afhjælpning af manglen. Er Randi A/S's forpligtelse ikke opfyldt inden udløbet af den fastsatte frist, kan køber hæve aftalen, såfremt manglen er væsentlig, eller, hvis manglen må siges at være uvæsentlig, kræve et forholdsmæssigt afslag i den aftalte købesum.
- 8.7 Randi A/S har, udover hvad der ovenfor er bestemt, intet ansvar for mangler, og køber kan derfor ikke gøre andre misligholdelsesbeføjelser gældende, end hvad der fremgår af ovenstående. Randi A/S hæfter således ikke under nogen omstændigheder, uanset eventuel grov uagtsomhed, eksempelvis for direkte tab eller driftstab, avancetab eller andre indirekte tab eller følgeskader, herunder for omkostninger forbundet med afmontering og indmontering.
- 8.8 Det forhold, at Randi A/S måtte opstarte drøftelser eller forhandlinger om en mindelig løsning af en reklamation, medfører ikke, at Randi A/S ikke efterfølgende kan påberåbe sig ansvarsbegrænsningerne i nærværende salgs- og leveringsbetingelser, og at der er sket for sen reklamation.
- 8.9 Det i nærværende pkt. 8 anførte, herunder med hensyn til begrænsningen af Randi A/S's ansvar, finder ligeledes anvendelse, såfremt det købte er behæftet med en retlig mangel, herunder eksempelvis såfremt det købte krænker en immaterialret tilhørende tredjemand eller er i strid med en offentlig-retlig forskrift eller ikke opfylder en sådan, f.eks. et CE-mærkningsdirektiv.
- 9. REKLAMATIONSPERIODE**
- 9.1 Randi A/S accepterer, at reklamationsperioden udvides fra 1 år, og således at den absolutte reklamationsfrist udløber 5 år efter afleveringen af det byggeri, hvori det købte indgår, dog højst 6 år fra overgivelsen af det købte til køberen.
- 10. FORCE MAJEURE OG LIGNENDE BEGIVENHEDER**
- 10.1 Randi A/S hæfter ikke for manglende opfyldelse af sine forpligtelser, som følge af omstændigheder, som ligger udenfor Randi A/S's direkte kontrol (f.eks., men ikke begrænset hertil, strejke, arbejdsnedlæggelse, blokade, lockout, forsinket eller mangelfulde eller væsentligt fordyrede leverancer fra Randi A/S's leverandører, forhindret tilførsel/levering af råstoffer, hjælpestoffer eller nogen anden leverance af tilfredsstillende kvalitet, brand, naturforhold, mangel på transportmiddel eller transportuheld, restriktioner vedrørende import/eksport samt driftsforstyrrelser eller standsning i øvrigt og lignende), som er egnet til at forsinke eller hindre fremstilling eller levering af det købte, eller som gør opfyldelsen væsentligt mere byrdefuld for Randi A/S end forventet.
- 10.2 Såfremt mangelfri eller rettidig levering hindres midlertidigt på grund af force majeure som nævnt i pkt. 10.1, suspenderes leveringsforpligtelsen i det tidsrum, forhindringen varer, og den således udskudte leveringstid anses i enhver henseende for rettidig, hvorfor køber er uberettiget til at hæve købet, så længe der foreligger en sådan begivenhed.
- 10.3 Såfremt Randi A/S vil påberåbe sig nærværende pkt. 10, er Randi A/S forpligtet til straks at give køber meddelelse herom med angivelse af årsag og den tid, forhindringen antages at vare. Randi A/S skal samtidig bestræbe sig på at overvinde hindringen hurtigst muligt og efterfølgende opfylde sine kontraktlige forpligtelser snarest muligt.
- 10.4 Såfremt en force majeure-situation varer eller af Randi A/S påregnes at vare udover 30 arbejdsdage, er såvel Randi A/S som køber berettiget til at hæve den indgåede aftale, uden at dette anses for misligholdelse. Køber kan derfor ikke kræve nogen form for erstatning fra Randi A/S i en sådan situation.
- 11. PRODUKTANSVAR**
- 11.1 Randi A/S er ikke ansvarlig for skader forvoldt af det købte, medmindre skaden skyldes forsæt eller grov uagtsomhed fra Randi A/S's side, eller der er tale om en personskade eller en forbrugertingskade. Uanset førnævnte er Randi A/S dog ikke i noget tilfælde ansvarlig for formuetab, driftstab, tidstab, avancetab, følgeskader eller andet indirekte tab, herunder, men ikke begrænset til tab som følge af købers retsforhold over for tredjemand.
- 11.2 Køber er forpligtet til uden ugrundet ophold skriftligt at meddele Randi A/S, såfremt køber bliver bekendt med, at der er indtrådt, eller at tredjemand påstår, at der er opstået en skade forårsaget af det købte, eller at der er fare for, at der vil indtræde en sådan skade.
- 11.3 I den udstækning Randi A/S måtte blive pålagt ansvar overfor tredjemand, er køber forpligtet til at holde Randi A/S skadesløs i samme omfang, som Randi A/S's ansvar er begrænset i henhold til nærværende pkt. 11.
- 12. JURISDIKTION OG LOVVAGL**
- 12.1 Enhver tvist, som udspringer af nærværende salgs- og leveringsbetingelser, skal afgøres efter dansk ret, dog eksklusive reglerne i den internationale købelov (CISG).
- 12.2 Enhver tvist skal afgøres ved retten i Randers som værneting i første instans. Førnævnte gælder dog ikke i situationer, hvor Randi A/S i en særskilt indgået byggeleveranceklauseul har accepteret, at tvister skal behandles af Voldgiftsretten for Bygge- og Anlægsvirksomhed. Køber er endvidere forpligtet, uanset førnævnte, til, såfremt Randi A/S måtte forlange det, at lade sig sagsøge ved samme forum, som behandler et påstået produktansvarskrav rejst mod Randi A/S.

**Materialprüfungsamt Nordrhein-Westfalen**

Prüfen • Überwachen • Zertifizieren

PRÜFZERTIFIKAT
TEST CERTIFICATE**Nr. 123000294-01**

no. 123000294-01

(Version 01)

(version 01)

Aufgrund der in der bauaufsichtlich anerkannten und gemäß DIN EN ISO 17025 akkreditierten Prüfstelle für Baubeschläge des MPA NRW durchgeführten Prüfungen wird bestätigt, dass

Due to the examinations accomplished by the according with DIN EN ISO 17025 accredited testing laboratory for building hardware of the MPA NRW it is confirmed that

das Bauprodukt
the building hardware

Drückergarnituren in Ausführungen entsprechend der
Zusammenstellung in der Anlage 1
lever handles as shown on the summary in annex 1

des Herstellers
of the manufacturer

Randi A/S
Mirabellevej 3
8930 Randers NØ
Dänemark / Denmark

mit den wesentlichen Anforderungen der
comply with the essential requirements of

DIN EN 1906: 2012-12 „Türdrücker und Türknäufe“; Anforderungen und
Prüfverfahren, Deutsche Fassung EN 1906:2012

DIN EN 1906: 2012-12 „lever handles and knob furniture“, Requirements and test methods, German version EN 1906:2012

geprüft wurde, und wie nebenstehend zu
klassifizieren ist:
It can be classified as

Beschläge mit 8mm Vierkant.
Die Klassifizierungsschlüssel sind der Anlage 1 zu entnehmen.

*Lever handles with 8 mm square spindle.
Further details on the classification can be seen in annex 1.*

Dortmund, 20.02.2020

Im Auftrag/ By Order

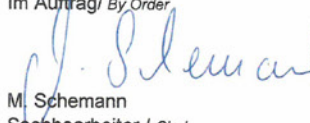
M. Schemann
Sachbearbeiter / Clerk

Dieses Prüfzeugnis umfasst 1 Seite und 1 Anlage.





Die Grundlage für dieses Prüfzeugnis bilden die MPA NRW Prüfberichte Nr. 123000294.01, 120004517.01, sowie der
Exova Warringtonfire Prüfbericht WF No. 143179, Issue 6.

*This test certificate comprises of 1 page and 1 annex.**This certificate is based on the test reports no. 123000294.01, 120004517.01 and the Exova Warringtonfire test report WF no. 143179, issue 6.**This document was originally written in German. In case of doubt the German version shall prevail.*



Line 18 – Türbeschläge – Edelstahl

Line 18 – door handles – stainless steel tube

| | | | | |
|---|---|---|---|--|
|  |  |  |  |  |
| 7020.04 | 7024.084 | 7021/7082 | 7020/7320 | 7020/7286 |



Klassifizierungsschlüssel nach EN 1906:2012





Classification acc. to EN 1906:2012

| | | | | | | | |
|---|---|---|----|---|---|---|---|
| 4 | 7 | - | B1 | 1 | 4 | 0 | U |
|---|---|---|----|---|---|---|---|

Drücker und Knopfvarianten

Lever handles and door knobs

| | | | | |
|--|--|--|--|---|
|  |  |  |  |  |
| 7020 | 7021 | 7024 | 7060 | 7062 |

| | | | | |
|---|---|---|---|--|
|  |  |  |  |  |
| 7065 | 7080 | 7082 | 7085 | 7087 |

| |
|---|
|  |
| 7090 |

